

# CHARCOAL PRODUCTION, MARKETING, AND USE

July 1961

No. 2213

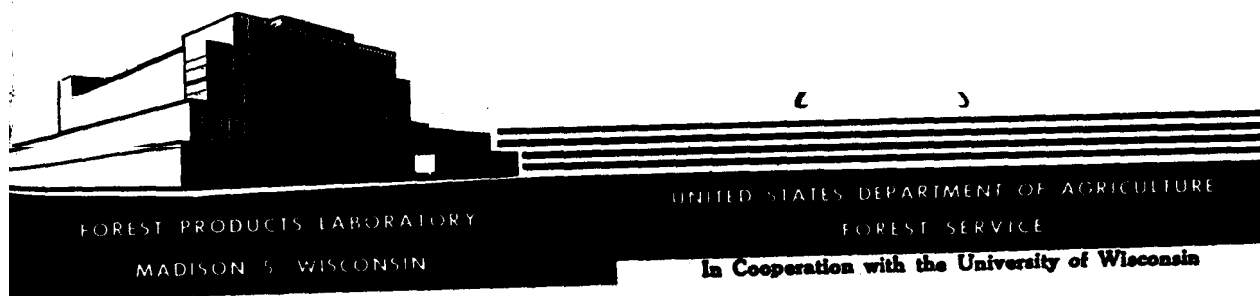

## TABLE OF CONTENTS

	<u>Page</u>
<b>Introduction</b> .....	1
<b>History and Status of Industry</b> .....	2
<b>Nature of Wood Charcoal</b> .....	3
<b>Development of the Industry</b> .....	4
<b>Early Kiln Methods and Production</b> .....	6
<b>Later Carbonization Methods and Production</b> .....	15
<b>Hardwood Byproduct Recovery</b> .....	16
<b>Current Production and Use</b> .....	22
<b>General Production Costs</b> .....	24
<b>Charcoal Markets and Marketing</b> .....	26
<b>Recreational and Industrial Outlets</b> .....	26
<b>Charcoal Briquetting</b> .....	27
<b>Forest Service Research</b> .....	36
<b>Scope of Program</b> .....	36
<b>Purpose of Research</b> .....	36
<b>Types of Experimental Structures</b> .....	37
<b>Structural Requirements of a Concrete Masonry Kiln</b> .....	51
<b>Size and Shape</b> .....	51
<b>Materials of Construction</b> .....	52
<b>Construction Details</b> .....	54
<b>Recommended Structural Practices</b> .....	61
<b>Operation of Rectangular Kilns</b> .....	62
<b>Kiln Raw Material</b> .....	62
<b>Kiln Charging</b> .....	63
<b>Temperature Measurement and Instrumentation</b> .....	63
<b>Charge Ignition</b> .....	65
<b>Safety Precautions in Kiln Operations</b> .....	80
<b>General</b> .....	80
<b>Types of Hazardous <i>Conditions</i></b> .....	80
<b>Safety Equipment</b> .....	82
<b>Location of Kilns</b> .....	83
<b>Safe Operating Practices</b> .....	84
<b>Charcoal Storage Precautions</b> .....	85
<b>Charcoal Yield and Production Factors</b> .....	86
<b>General</b> .....	86
<b>Measuring Yield by Charcoal Percentage</b> .....	87
<b>How to Determine Charcoal Conversion</b> .....	87
<b>Effects of Operating Conditions on Yield</b> .....	89
<b>Wood Moisture Content and Yield</b> .....	89
<b>Wood Moisture Content and Conversion Time</b> .....	90

## TABLE OF CONTENTS

(continued)

	<u>Page</u>
Wood Moisture Content and Brands .....	90
Effect of Wood Species, Form on Weight of Charge .....	91
Effect of Species, Form on Charcoal Yield, Quality .....	94
Effect of Kiln Size, Type on Charcoal Yield, Quality .....	95
Effects of Kiln Size, Type on Production Time .....	95
Effect of Time, Temperature on Coaling and Charcoal Quality....	95
Effects of Time, Temperature on Kiln Operations .....	99
Effect of Time, Temperature on Brands.....	99
Effect of Weather on Charcoal Yield .....	101
Effects of Weather on Carbonization Temperature .....	101
Economic Studies .....	103
Kiln Comparison Study .....	105
Stand Improvement Study .....	108
A Method of Charcoal Analysis .....	112
Procedure for the Analysis of Charcoal .....	116
Sample Preparation .....	116
Steps in Analysis .....	116
Conclusions .....	119
Appendix--A Partial List of Suppliers .....	121
Charcoal Moisture Tester .....	122
Requirements for Temperature-Indicating Meter .....	122
Wire Requirements .....	123
Wiring.....	123
Meter Use and Care .....	126
Wire Use and Care.....	127
Literature Cited.....	127-135

## Acknowledgment

**This report provides general information in the field of charcoal production and summarizes the results of Forest Service investigations concerning the design and operation of masonry type kilns. The conclusion of the project was made possible by the helpful cooperation of several private, State, and Forest Service organizations. Significant contributions of either funds, personnel, or raw materials were made by the Cliffs-Dow Chemical Co., Kingsford Chemical Co., State of Minnesota Iron Range Resources and Rehabilitation Commissioner, North Carolina Conservation and Development Commission, St. John's University, Collegeville, Minn., the University of Georgia, the University of Minnesota, the Wisconsin Conservation Commission, and the Lake States Forest Experiment Station, Southeastern Forest Experiment Station, and Forest Products Laboratory of the Forest Service, U.S. Department of Agriculture.**

**This report was prepared by the following Forest Service personnel: Arlie W. Toole, Paul H. Lane, and Carl Arbogast, Jr., of the Lake States Station; Walton R. Smith and Ralph Peter of the Southeastern Station; and Edward G. Locke, Edward Beglinger, and E. C. O. Erickson of the Forest Products Laboratory.**

# CHARCOAL PRODUCTION, MARKETING, AND USE

Compiled by the Forest Products Laboratory<sup>1</sup>

## INTRODUCTION

Charcoal is produced by heating wood in airtight ovens or retorts, in chambers with various gases, or in kilns supplied with limited and controlled amounts of air. High-temperature heating by all methods breaks down the wood into gases, a watery tar mixture, and the familiar solid carbon material commonly known as charcoal.

Carbonizing ovens of plants designed for recovery of products other than charcoal are heated externally, and the wood is not in direct contact with the heat source. In another type, the only heat source derives from utilization of reaction heat for continuous chip conversion. Upright chambers have been developed that convert fines continuously or chunks in batches by forced circulation of hot gases through the wood, but liquid byproducts are not recovered. Also, horizontal retorts, both rotating and fixed, have been devised for the continuous carbonization of hogged material or raw mill fines. In kilns, the wood is heated directly and itself largely furnishes the heat needed for combustion. This report presents data on charcoal kiln design and operation developed by research and developmental work of the Forest Service, U.S. Department of Agriculture, in various parts of the United States. Its object is to aid producers in more efficiently converting large quantities of low-quality wood into a product that is enjoying an encouraging resurgence in popularity as a cooking fuel for use in homes, recreational areas, restaurants, and other establishments.

Charcoal has been an important domestic product for many years and, regardless of how produced, has wide market acceptance. Its greatest use is for home and outdoor recreational cooking. Charcoal is also used in the manufacture of carbon disulfide, carbon tetrachloride, sodium cyanide, and other industrial chemicals. Extensive amounts are converted to activated carbons. Other industrial uses are in connection with steel heating, nonferrous smelting, and metal casehardening.

Large amounts of charcoal are used as recreational fuel, and production will continue to expand as this use increases. This market has stimulated interest in the manufacture of charcoal. To small businessmen and investors it is particularly attractive, since a charcoal production venture can begin with but little investment in simple kilns and expand into more elaborate conversion facilities as business warrants. The investment for kiln construction would

<sup>1</sup>Maintained at Madison, Wis., in cooperation with the University of Wisconsin.

be in the general range of \$100 to \$500 per cord of kiln capacity, not including costs of warehousing and mechanical equipment. For the more complicated equipment of either small or large size, the investment would be from about \$2,000 to \$35,000 per cord of conversion capacity.

Whether a charcoal operation will be successful is not assured by the initial plant investment but depends on a study of commercial possibilities as indicated by source and cost of raw material, availability and cost of labor, and the market for the charcoal produced. Wood and labor costs, operational efficiency, and sound marketing practices are the chief economic factors governing success in charcoal production.

When there are possibilities for the marketing of rather large amounts of charcoal, a cooperative operation may help assure more efficient use of labor, permit joint advertising and sales, and result in higher profit.

Charcoal will undoubtedly continue to be made for the most part from wood. This report provides information for the manufacture of charcoal in various kinds of equipment, from rather simple, inexpensive kilns to elaborate, costly byproduct-recovery plants. This information is based on Forest Service research conducted on a broad scale to stimulate conversion of low-quality wood to this widely marketable product. It is emphasized, however, that only when certain controlling factors, such as initial investment, labor and raw material costs, production efficiency, and markets, are fully considered can there be reasonable assurance of success. The important role these factors play in charcoal production is clearly shown in experience gained from experimental kiln production. Charcoal is produced by heating wood under conditions that permit the use of little or no oxygen or in limited, regulated amounts available for retarded combustion. That this point has particular significance is emphasized in much of this report.

## HISTORY AND STATUS OF INDUSTRY

Charcoal is produced by burning wood under conditions that severely limit the amount of oxygen available for combustion. The object is to reduce the wood to a form of carbon by removing the other constituents. These are either allowed to escape as gases and other volatiles in the smoke, or may be recaptured, condensed, and converted to useful byproducts. Because of their removal in large part, charcoal burns more "cleanly"--that is, with little or no smoke or flame.

## Nature of Wood Charcoal

In the kiln, heat converts wood to charcoal in two stages--the drying and the coaling stage. The heat needed for drying and to initiate coaling conditions is furnished by burning part of the wood. Additional heat is given off by chemical reaction during the coaling process. The burning is controlled by limiting and regulating the amount of air entering the kiln.

After an initial surface zone of dry wood has been established, further heating breaks the wood down--that is, chars it--to form charcoal progressively throughout a kiln charge. Water vapor and the burnable gases that are supplied with too little oxygen for complete burning escape as smoke through one or more kiln stacks (16,22,37,42).<sup>2</sup>

Charcoal is obtained from all species of wood. The charcoal, or impure carbon, yielded by the various commercial methods is usually considered adequately refined for its markets. The carbonization, or so-called "coaling," temperatures used control the amounts of volatiles or smoky material remaining in the charcoal (34). If coaling temperatures are too low, excessive amounts of volatiles will remain in the charcoal and cause heavy smoke when it burns.

The yield of charcoal from a given amount of wood by weight is dependent upon the amount of carbon in the wood and the carbonization conditions employed. On the average, carbon constitutes about 50 percent of the dry weight of the wood. At least this amount is likewise present in hardwood barks, while softwood barks contain somewhat less.

Good-quality charcoal burns cleanly and has a heat value of about 13,000 British thermal units per pound (59), or about 1-1/2 times that of an equivalent weight of dry wood. This important property, along with its low average ash content, 2 to 3 percent, makes charcoal desirable for metallurgy or as a domestic fuel. Only traces of sulfur and phosphorous are found in charcoal (3). This further increases its value in metallurgy, but the cheaper carbons obtained from other sources tend to offset these important charcoal properties.

Charcoal produced under well-controlled carbonization conditions may be hard and brittle, or comparatively soft and crumbly, when rubbed and handled.

In weight, charcoal may be rather heavy to quite light. This physical property is related to the weight of the dry wood of the various species, which in a given volume may be heavy (sugar maple, beech, oaks, yellow birch,

---

<sup>2</sup> Underlined numbers in parentheses refer to Literature Cited at end of this report,

longleaf pine, and the hickories all have an average specific gravity of 0.63<sup>3</sup> (79); medium (elm, alder, soft maple, ash, gum, yellow-poplar, Douglas -fir, and jack pine have an average specific gravity of 0.48<sup>3</sup> (79); and light (aspen, cottonwood, and most softwoods, with an average specific gravity of 0.39<sup>3</sup> (79). Well-prepared charcoal weighs about one-third as much as wood and is reduced to roughly one-half the volume of wood. In form and internal structure, it is almost identical to wood. The apparent specific gravity of charcoal ranges from about 0.2 to 0.5, depending on the specific gravity of the wood from which it was made.

Traditional indicators of charcoal quality include a metallic ringing sound given off when it strikes a hard object, and a smooth fracture of the piece as it breaks. Others include freedom from taste and odor and from undue soiling of an object that is rubbed against a fractured face.

Charcoal is comparatively easy to ignite, and when of good quality burns evenly and without smoking. Because of its low strength and brittleness, it tends to crumble and produce "fines" or small pieces when handled roughly. Handling during kiln discharge and transport normally reduces about 5 to 10 percent of the charcoal to fines.

By comparison with generally accepted standards, wood charcoal has little tendency to adsorb colors, gases, or odors. Since it is porous, however, it has a large internal surface area that can be materially modified by activation to adsorb greater amounts of these materials. Charcoal becomes activated when heated at high temperature in the presence of air, steam, carbon dioxide, or combinations of these gases. Other chemical treatments also modify or increase its adsorbency for specific uses. The production of activated charcoal is highly specialized and requires both heavy plant investment and large raw material supplies.

Under certain conditions, charcoal will undergo self or spontaneous combustion, the cause of which is not clearly understood. Heat is generated in charcoal both by wetting and by taking up oxygen. Properly conditioned charcoal is a relatively inert or stable material and may be compactly dry stored for indefinite periods.

### Development of the Industry

During Colonial days charcoal was produced in simple pit or earthen kilns for carbon needed in iron smelting (69,80). This type of kiln is still in limited use (fig. 1). Toward the end of the 19th century, charcoal production for metallurgical uses amounted to about 171,000 tons annually, and was

---

<sup>3</sup> Based on weight when oven-dry and volume at 12 percent moisture content.





**Figure 1. --Early charcoal production in earth kilns.**

**ZM 113 846**

concentrated chiefly in the northern hardwood belt (39). During this period, the beehive-type structure (fig. 2) largely replaced the pit kiln (39,56).

After slumping to a low of 6,000 tons in 1935, kiln production has returned to an annual level of over 55,000 tons (73).

About 1890, production of acid for textile manufacture became important in conjunction with charcoal manufacture in large beehive kilns, further stimulating expansion of the industry. As a result, plant facilities for charcoal and chemical byproduct recovery became more elaborate and expensive. In these operations a crude liquor was obtained by condensation of distillation volatiles. The liquor was refined in highly specialized equipment to yield mainly pure acetic acid and methanol (21,22,39,50,52).

The year 1909 recorded peak charcoal production of slightly more than 550,000 tons from kilns and recovery plants. Between about 1910 and 1940, production dropped to 250,000 tons, chiefly because other carbon materials replaced charcoal in the manufacture of metals and chemicals. After a further decline to a low of 213,000 tons reported for 1947, however, production has recovered, reaching 265,000 tons in 1956 (4).

### Early Kiln Methods and Production

Historically, in the United States, crude earthen pit kilns were the forerunners of the modern charcoal kiln (15). Occasionally, one is still found in use, but during the latter half of the nineteenth century so-called "beehive" kilns came predominately into use.

In earthen pit kilns, sound, seasoned pieces of hardwood about 4 feet long and 6 to 8 inches in cross section are piled in mounds of as much as 50 to 90 cords. Earth is mounded over the wood to give a firm enclosure, but is not too tightly packed to prevent air from leaking through to the wood. About 20 days are needed to coal a wood charge of 50 cords by this method. While the yields of marketable charcoal are low--about 700 pounds of charcoal per cord--overall costs are held down by the very small investment in plant, despite the fact considerable labor is required to make a suitable coaling structure (80).

The brick beehive kilns of 50- to 90-cord capacity once widely used were of no uniform design. The larger kilns are estimated to have had an overall height of 24 feet, a diameter of 30 feet, and a wall thickness of about 12 inches. The dome-shaped ceiling had an opening for loading and firing. Some kilns of this type continue in use today and do an effective job.

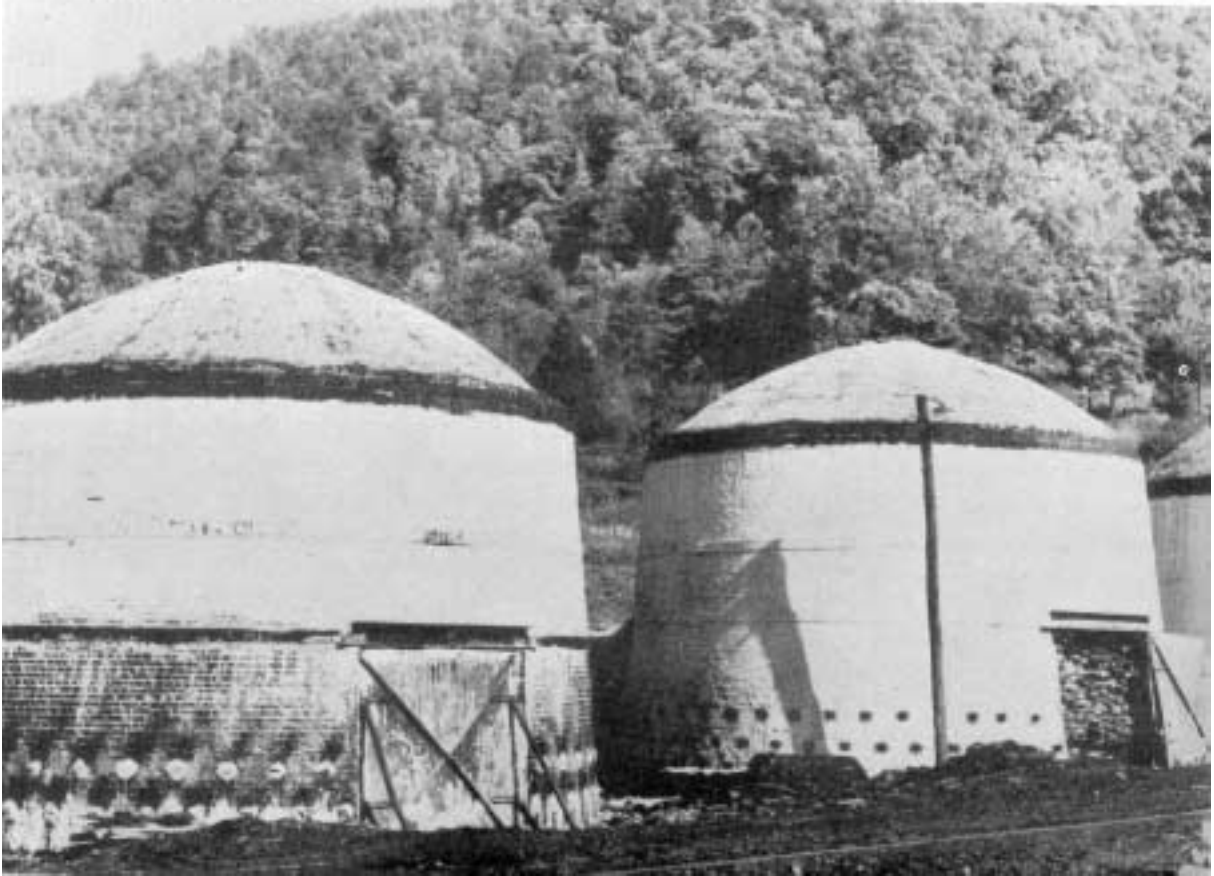

**Figure 2. --Brick beehive kilns --large-scale conversion of low-grade wood.**

**ZM 113 742**

Two Midwest operations, each with several 75-cord beehive kilns, were started in 1956 (fig. 3) and 1959. In general, such kilns are built along the base of a hill or bank, so that they can be conveniently charged through the top. An opening at the base also gives access for wood piling and for charcoal discharge. Raw material of mixed or uniform size, such as cordwood, stems, and slabs, is closely stacked for maximum charge weight. A 2- to 3-foot central core in the charge is filled with small and short-length fuel almost to dome height for charge ignition.

After ignition is well under way, the top is tightly closed and the bottom door made airtight. A number of air-inlet ports around and near the base of the kiln regulate intake of air for partial combustion, and ports located somewhat higher in the wall permit the smoke to escape after it has circulated throughout the charge. Because of varying wind and other atmospheric conditions, the ports must be skillfully operated to assure uniform coaling of such large amounts of wood. Different inlet and outlet ports are opened or closed as the operator deems necessary to get the coaling pattern desired.

The end of the coaling period is indicated generally by the amount and nature of the smoke from the ports and by observing, through them, the conditions within the kiln. A complete cycle takes from 20 to 30 days, and about 700 pounds of charcoal per cord of seasoned wood are produced.

The high-volume production possible in beehive kilns, especially where wood can be bought at low bulk prices, enables the operator to enter into contracts to furnish large amounts of charcoal. Commonly, batteries of these kilns are operated to keep labor steadily employed (69).

Many different types and sizes of kilns have come into use from time to time. Likewise different construction materials have been used, often with no set design or structure in mind. Good planning, however, has resulted in kiln structures that function well.

An example is the successful, and still rather widely used, Black Rock Forest beehive kiln (77) developed in the early 1930's (fig. 4). This kiln, constructed of 14- to 16-gage sheet metal, is 7 feet in diameter at the base, 4-1/2 feet in diameter at the top, 5 feet in height, and holds about 1/2 cord of 4-foot wood stacked on end. Eight 4-inch ports are equally spaced around the base, and in alternate ports are four smokestacks and four air-inlet openings. This kiln is constructed in three sections, a base, a midsection, and a crown, and is therefore portable. A larger version of this kiln, about 1-1/2 cords in capacity, can be charged with cord-length wood uniformly piled or with short-length material dumped in. Fairly low maintenance cost, portability, and short operating schedules are reported. In comparison with masonry kilns, their chief disadvantages are excessive radiational heat loss



**Figure 3. - -Beehive kilns - - recent construction of 75-cord units.**

**ZM 114 998**



**Figure 4. --Portable, sectional sheet-metal kiln.**

**ZM 113 851**

that results in somewhat lower yields and, as compared to masonry-block Kilns, generally higher kiln cost per cord of capacity.

Changes in design and use of these small, metal beehive kilns led to the development of the New Hampshire-type kiln first operated about 1938 (9,10,11,12). This kiln has a beehive-shaped, sheet-metal hood with a shallow top plate. The design permits lifting and transporting the whole kiln. For operation, a derrick lowers the units over charges of wood stacked around it and lifts them after coaling is completed. Batteries of these kilns can be operated efficiently, with loading, coaling, and discharging going on at different times.

Masonry blocks, various types of bricks, field stone, and reinforced concrete are commonly used in kiln construction (49). Some have capacities of 25 to 40 cords. Others, of about 2- to 10-cord capacity, are more popular because of lower initial cost and ease of operation (28,29,35,37,54,55,67,69). Even modified brick kilns originally built for the manufacture of ceramic materials or coke are satisfactory (fig. 5). Such units have wood capacities of from 45 to 65 cords and can withstand the high coaling temperatures with little cracking and damage to the structure. In a good location, these structures can be economically operated for charcoal manufacture, in part because similar new construction would require a considerably greater investment. Units of reinforced concrete, having capacities of 45, 60, and 100 cords of wood, are used to quite a large extent (fig. 6) (38). These kilns usually have a number of stacks, and it is rather common practice to cover all but the front with dirt. Kilns of similar design but smaller in size are constructed of brick (fig. 7) (49).

The commonly used 2- to 10-cord masonry-block kilns are simple in design, low in cost, and produce consistently good yields of charcoal.

Field experiments in the development of single-stack, rectangular, masonry-block kilns of 1- or 2-cord capacity were reported by H. W. Hicock and associates of the Connecticut Agricultural Experiment Station in a series of publications beginning in 1946 (35,37,54,55). In an earlier publication, they described the construction and operation of 2- and 4-cord sheet-metal kilns of somewhat similar design (36). In the smaller masonry-block kilns, there was considerable wall cracking and other structural damage at high operating temperatures, which necessitated continuous, although generally inexpensive, repairs. Experience gained with commercial operation resulted in some structural changes. The chief features, however, remained unchanged. These provided for air entry through ports along each sidewall at groundline and a single smokestack at the rear. The original design also featured a small stove or heating chamber that helped improve the flow of air through the kiln.

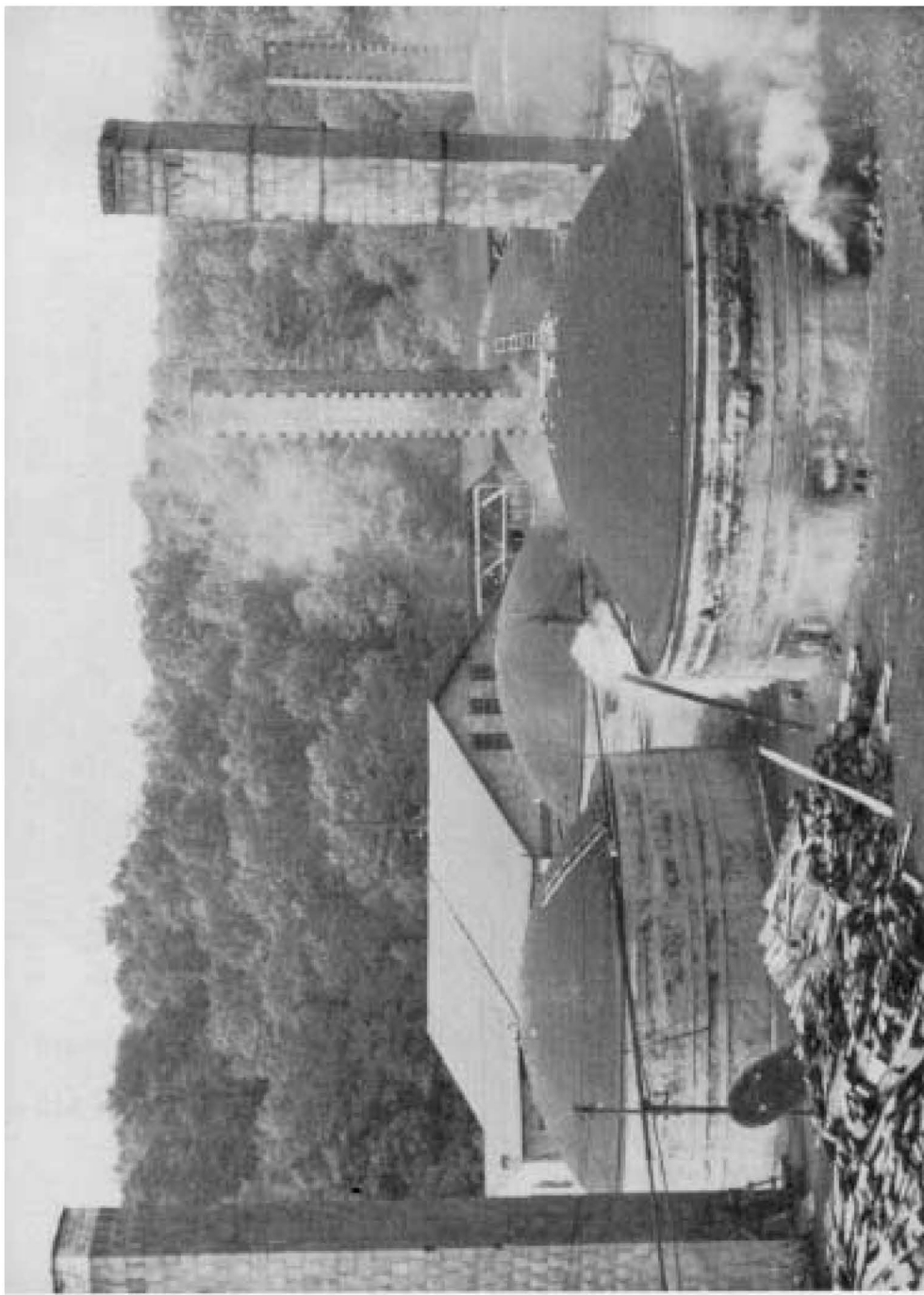

**Figure 5. --Ceramic kilns converted for charcoal manufacture.**

**ZM 82963 F**



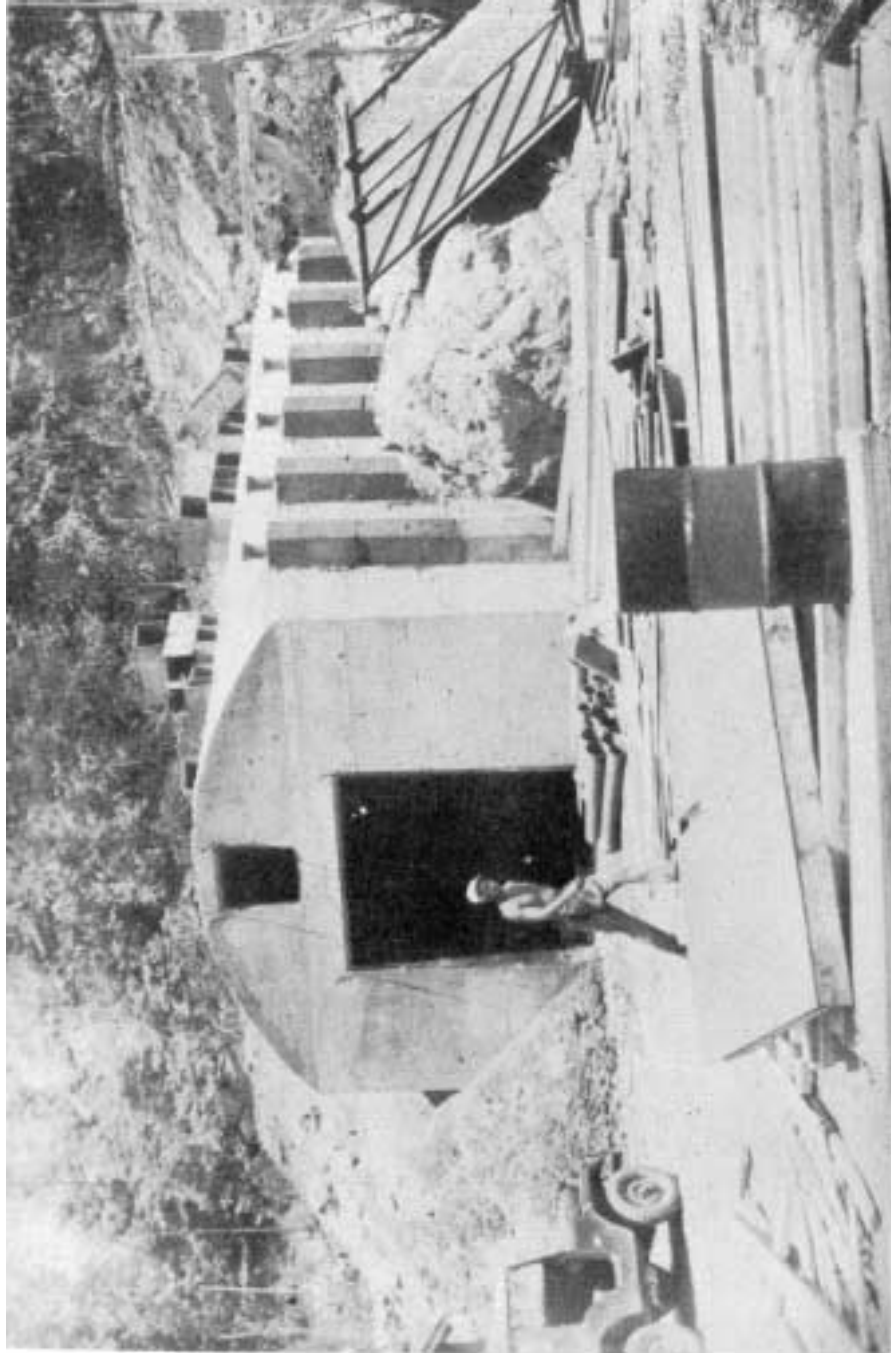

**Figure 6. -- Concrete kiln of 100-cord capacity.**

**ZM 114 261**

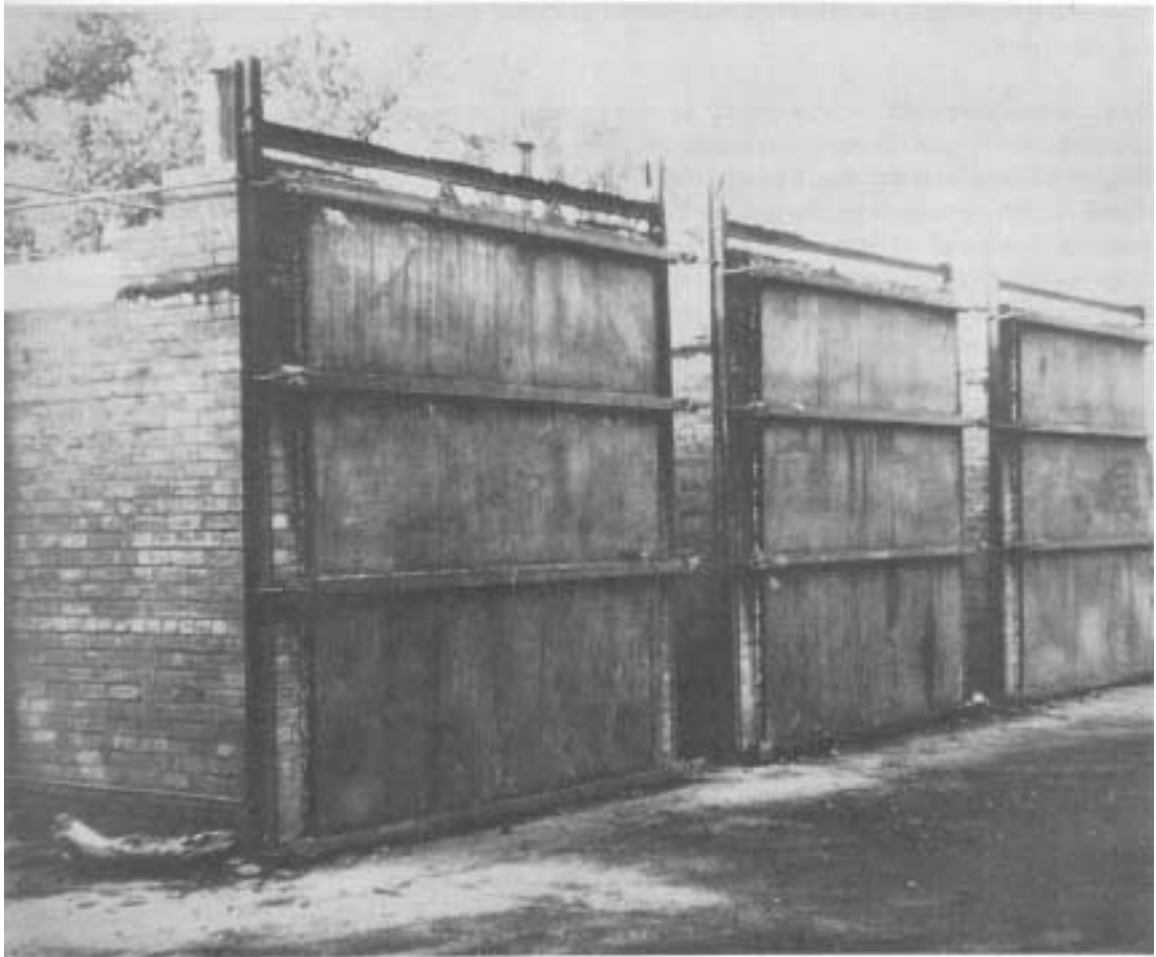

**Figure 7. -- Commercial, rectangular brick kiln with steel doors.**

**ZM 112 468**

The spreading interest in charcoal production has brought into use still other types of kilns. These are generally small and designed and built by the operator to supply a limited market. Among these are a number of interesting designs.

One, a "telescopic" type unit, is made up of a rectangular-shaped, wrap-around sheet-metal base section and an edge-flanged top or overskirt section slightly larger than the base. Half a cord of material, usually slabwood, is piled on the ground to fit within the kiln. The split lower section is wrapped around the base of the charge, and the upper section is placed over the top of the charge. During coaling, as the charge shrinks, the top section moves slowly downward, overlapping the bottom section until it reaches the ground. Dirt is banked around the base.

Another low-cost type consists of a dry brick inner wall 7 feet in diameter and 4 feet high and an outer wall of 28-gage roofing tin. A 2-inch space between the walls is filled with sand to seal any gaps. Four draft and four smoke openings are located around the base. Wood is lowered into the kiln through the ceiling, and the charcoal is lifted out the same way. Twenty-eight-gage sheet metal is used for the kiln ceiling, which is removable and acts also as the entrance closure. The ceiling is supported by iron pipe stringers placed crosswise at right angles. A 2- to 4-inch layer of sand is used to seal the top. Initial draft and ignition smoke pass through a stack in the center of the ceiling. Construction has included chiefly salvage material and points out the possibilities for lower construction investment.

### Later Carbonization Methods and Production

The development of wood distillation plants about 1890, as already noted, created a new source of charcoal that continues to produce substantially more than is made in kilns. In recovery plants charcoal is produced in large amounts and is at least as important as the methanol, acetic acid, and other wood chemicals produced.

Byproduct charcoal from such recovery plants has an obvious advantage in that costs of production are shared by the sale of the chemical products. By the early years of the twentieth century, therefore, the bulk of production had been taken over by these more efficient oven facilities, which continued to flourish until about 1920 (39). Between 1920 and 1940, conditions changed radically, and many of these plants were abandoned because of the economic pressure of high investment and loss of chemical markets to cheaper synthetics. Those managing to remain in business, however, got an unexpected assist when, about 1950, a new market of great potential opened

for charcoal as a cooking fuel in homes --indispensable to the now familiar backyard barbecue.

### Hardwood Byproduct Recovery

Approximately one-half of all the charcoal produced in the United States comes from six hardwood byproduct recovery-type plants. Four plants produce acetic acid and methanol, while in another only methanol is recovered. In the sixth, acetic acid is recovered indirectly as sodium acetate. In these plants charcoal is made by conventional oven carbonization as well as by other, quite different methods. In all six plants, the main operating steps are: (1) the wood is predried and carbonized; (2) the crude liquid obtained is refined for recovery of high-purity products.

Oven processing. --The typical oven operation is a batch process (21,34,39). The horizontally placed sheet steel ovens hold approximately 10 cords of wood cut to either cord or short-block lengths. The ovens are commonly set in pairs and heated externally from end-placed fire boxes. Steel rails on the oven floor and in line with yard and charcoal cooler tracks allow car charging and discharging to take place at the same time. Full face swinging doors at both ends are made gas tight by wedging against the door frame. Heat loss is greatly reduced by use of an additional exterior, or storm, door at each end. The volatile products are led from the oven through side-wall takeoffs to water-cooled copper or stainless steel condensers.

Coal, manufactured and natural gases, and oil, with the addition in some cases of wood tar and gases from the carbonization, are the chief fuels used. Controlled heating of the ovens to an end temperature of about 800° F. is necessary for satisfactory yields of good-quality charcoal and refined by-products. Carbonization periods vary from 18 to 22 hours and are so arranged that a number of ovens can be charged and discharged at different times. The charcoal is withdrawn to tight, sheet-steel coolers at the same time a charge of wood enters the ovens from the yard or from the predriers, A minimum time of 48 hours in the coolers and 48 hours in covered sheds is required for conditioning the charcoal before it is shipped. From 1,000 to 1,100 pounds of charcoal are generally obtained from a cord of the heavier hardwoods in recovery plants. It is estimated that, at recent prices, an investment of \$35,000 per cord daily capacity is required for new plant construction, and that an input exceeding 100 cords per day is necessary for profitable operation (fig. 8).

Stafford retort processing. --The type of equipment and method (52) employed in wood distillation by the Stafford retort process vary widely from those used in oven carbonization. The major difference is that carbonization is conducted

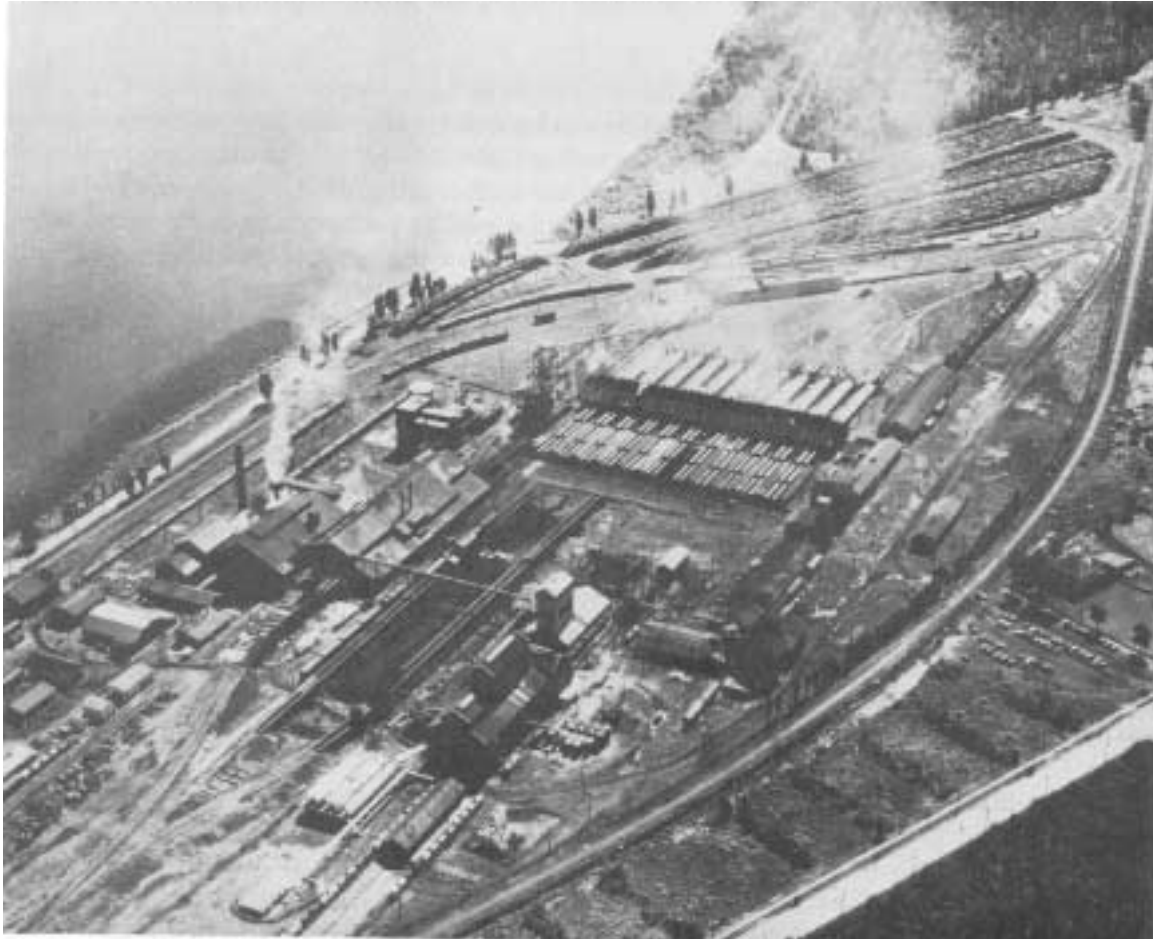

**Figure 8. --This hardwood byproduct recovery plant includes carbonization and refining facilities for the production of acetic acid, methanol, and charcoal in lump, briquette, and activated forms.**

**ZM 113 849**

continuously in vertical retorts without auxiliary heat. Wood that has been chipped, hogged, or cut into small blocks is used.

The efficient predrying of process wood to low moisture content is necessary for satisfactory operation. Rotary driers heated by the gases from the power plant are used to dry the wood to a moisture content of about 0.5 percent. The dried material is automatically fed to the retorts in regulated amounts.

The retorts are about 40 feet high and 10 feet in diameter, and heavily insulated. Provision against heat loss must be made, since proper heat balance within the retort is a controlling factor in the operation. Valves at the top and bottom ends of the retort prevent air from entering with the raw material and also prevent the escape of volatile products. The dried wood is fed to the retort at a temperature of about 300° F. As it moves downward, both its temperature and its rate of carbonization increase. Carbonization is carried on by making use of the heat that is continuously available from added wood undergoing similar change to charcoal. Heat is concentrated at highest temperature in a zone about midpoint of the retort. The average temperature in this zone is about 950° F. and gradually decreases to about 480° F. at the base.

Volatile materials pass from outlets at the top of the retort to four evenly spaced condensers. The charcoal is discharged continuously to airtight coolers and conditioners in a finely divided form that has limited markets, but with a little grinding is made readily suitable for briquette, manufacture. About 1,000 pounds of charcoal are obtained from a cord of the denser hardwoods.

Gas-circulating process. --Processes different from the oven method (21) in common use were developed in Germany by Reichert (48,64,65) and in Belgium by Lambiotte (43). These methods have been successfully used in several European plants to overcome serious problems of high wood and labor costs. In at least one United States operation, some use is being made of one method.

In principle, the carbonization methods developed by Reichert and Lambiotte are alike. They differ from other systems, however, in that hot, non-combustible gases are circulated throughout the charge to carry on the carbonization. Although the Reichert plant is operated with batches of raw wood and that of Lambiotte is continuously fed with wood, it is understood the Reichert plant can be made continuous also.

While the heating gases in the Reichert system flow downward with the wood through the retort and those in the Lambiotte retort travel against the direction of wood movement, both methods may be described briefly together.

The retorts are cylindrical with tapered end sections and vertically mounted for single or group use. Both top and bottom sections of the Lambiotte retort are equipped with special valves to permit loading and discharging without intake of air or loss of wood gases and vapors. In the operation of both types of retorts, heated wood gases enter the retorts through valved openings, spread throughout the charge, and later go with newly formed volatiles to condensers. A portion of the dried gases from the condensers is transferred under slight pressure through furnace tubes and heated to a high temperature by combustion of the remaining portion. Passage of the heated gas from the furnace to the retort completes the cycle. Gas recycling and circulation within the retort are automatically controlled. The yield of charcoal per cord is much the same as that from other processes using similar hardwood raw material.

Converted byproduct-plant processing. - - Some 25 years ago, operators of hardwood recovery plants lost their major byproduct markets and were forced to limit output to charcoal. This necessitated some plant changeover, which was made by removing the equipment for the recovery and refining of the liquid byproducts. The oven equipment required only minor modifications and was left to remain as a complete carbonizing unit. This usually required that all of the gases from the ovens be passed through condensers for drying before venting them to the atmosphere, to an outside furnace, or to the oven fire boxes for use as supplementary fuel. Burning was preferred, since direct venting to the atmosphere could be both a nuisance and a possible health hazard. The charcoal from such modified plants was produced at generally favorable tonnage costs.

Resinous wood byproduct recovery. --Horizontally placed, cylindrical steel retorts have been in general use for the carbonization of highly resinous slash and longleaf pine stump wood (17,34). Fire boxes are located at one or both ends of the retort, depending upon its length. In some operations the retorts are sufficiently large for car loading; in others they are charged and discharged by hand. The process is varied also by the use of concrete carbonizing chambers, to which heat is supplied through pipes placed on the inside. Since the bottom of the retort is not heated, much of the higher boiling liquid produced can be drawn off at the bottom without major change, and other materials in vapor form can be passed through the side outlets to condensers.

Charcoal, pine tar, and solvent oils are the principal products obtained. After a carbonization period of about 24 hours, the charcoal is removed and cooled in tight receivers. Because plant operation varies, it is difficult to indicate the average yields of products obtainable from the stump raw material. Moreover, the raw material may vary widely in resin content, affecting yields. The most probable yields of charcoal are within the range of about 700 to 750 pounds per cord of wood. Based on information available

several years ago, an estimated investment of \$25,000 per cord of daily capacity would be required for new plant construction.

Other retort processes. --Carbonizing equipment somewhat different from the types in general use has been recently developed for commercial operation. The equipment has been designed to utilize mainly short-length mill and forest waste material or mill fines, and recycled hot gases.

For convenience, these types may be grouped to include (1) the small vertical coaling chambers operating batchwise or continuously on chunk or short-length raw material and (2) those operating vertically or horizontally with forced movement of the wood particles for continuous carbonization.%

The vertical retorts are cylindrically shaped and constructed of sheet metal both with and without exterior insulation (3, 41, 71). All are portable to the extent that the major operating parts may be dismantled and reinstalled at other locations without great difficulty. Six retorts of the vertical type operate batchwise, and one provides a continuous output of charcoal. The charcoal is discharged at the base of the retorts.

For one such batch retort, a separate oil burner provides heat at controlled temperatures of 700° to 900° F., depending somewhat on the species of wood to be carbonized. A coaling period of 7 to 8 hours is needed on the average for a charge of about 9,000 pounds of green slab and edging material cut into 12- to 16-inch lengths. Production is at a reported rate of about 2-1/2 tons of charcoal each 24 hours. The investment in this retort installation is understood to be about \$15,000.

Reportedly, continuous operation in the vertical-type installation provides for primary recycling and partial burning of the wood gases to maintain carbonization conditions. The charcoal is withdrawn at intervals from the base of the retort into water-sealed metal drums. The amount of charcoal obtained for each 8-hour shift is about 2-1/2 tons from chiefly short-length slab and edging material. A reported cost for this type of installation is about \$25,000. More recent installations and commercially operated vertical-type retorts are comprised of units of different design. These units employ 5 internal, vertically placed flues which allow simultaneous withdrawal and combustion of wood gases for heat supply to the wood charge (63). The production rate is reported at about 2-1/2 tons of charcoal per day at one location, and production cost about \$18 per ton.

---

<sup>4</sup>A partial list of retort manufacturers or distributors is available from the Forest Products Laboratory, Madison 5, Wis.



**In three different commercial methods, horizontal tubes or chambers are utilized for continuous charcoal output. In one the carbonizing equipment includes three rotating steel tubes, each fitted with an endless screw for continuous feed and travel of the chip or sawdust raw material. Heat is applied on the outside to start carbonization and is stopped when the coaling can proceed unaided. Each tube is designed so that carbonization occurs in the forward half of the tube and the charcoal is cooled in the remaining portion. Estimated production has been placed at about 5 tons from each tube over a 24-hour period.**

**A second method makes use of radiant heat for the carbonization of small wood particles or chips. Coaling is done continuously as the wood travels on an endless belt over electrically heated steel platens. Across the heated section of the equipment, about 27 feet in length, travels a 3-inch layer of chips subjected to a temperature of about 750° F.**

**The third method requires a unit of brick and concrete construction about 31 feet long, 15 feet wide, and 12 feet high (27). A single metal tube with screw conveyor carries various kinds of wood fines to a hopper for distribution to a number of horizontal tubes mounted across a wood-gas firing chamber for direct external heating. After passage through the carbonization tubes, the charcoal is discharged to a single exit tube for movement by screw and duct to airtight metal receivers. The main structure has a combustion chamber at the lowest level, which provides heat to the area in which the carbonization tubes are located. In operation, the combustion chamber is fired for an initial period of several hours to obtain a preprocessing temperature of about 800° F. When coaling is underway the retort volatiles or gases are dried by movement through condensers and passed to the chamber for combustion. The carbonization process is continued by heat furnished from the burning of these gases only. The reported yields have been within a range of 5 to about 9 tons for a 24-hour operating period, depending upon raw material size and moisture content. The estimated investment for a single unit with predrier is reported to be between \$125,000 and \$150,000.**

**Continuous carbonization of wood fines on a commercial basis is anticipated from a vertical-type unit varying markedly in operation from those just outlined. Processing involves a form of fluidized-bed technique which brings about, by forced air, an upward travel of the fines, which are heated by combustion of a mixture of entering air and decomposition gases given off by the heated wood. The carbon fines are recovered by passing them through cyclone separators.**

**Along with the more recent commercial developments in wood fines carbonization, important progress has been made in a further type of semicommercial equipment operating continuously (66). Equipment includes a rotary and a**

slightly inclined horizontal tube for feed agitation and travel. The carbonization heat is introduced into the tube from an outside source. Mill-run Douglas-fir sawdust has been used as the feed material, and all byproducts were recovered. The results of this work indicate encouraging commercial possibilities.

### Current Production and Use

Of the numerous methods herein described for producing charcoal, kiln production is perhaps of greatest interest because of the low plant investment needed and its operational simplicity (11,16,22,69,70,88,89). New interest in the practical utilization of mill fines and other wood residues is shown as well by the recent development of several types of commercial systems.

The most recent national production figures available are 264,990 tons for 1956. More recent production, however, is undoubtedly greater. There was a continuous and fairly substantial rise from the 213,660 tons reportedly produced in 1947. Between one-fifth and one-fourth of the tonnage reported for 1956 was produced in 232 kiln operations comprising approximately 1,500 units (4). Kiln concentration is greatest in the Eastern Great Lakes and South Central regions. California is the only western State with a significant number of operations (32).

Among the 1,500 units operated in 1956, there were only a few earth kilns but a considerable number of the brick, beehive-type kilns. The most popular type, comprising about 600 units, was of concrete or masonry blocks holding from 1 to about 25 cords. Less common, but nevertheless important, are the sheet-metal kilns and those of brick construction.

Kiln construction during the past several years has consisted chiefly of these latter three types. As already noted, some of the more recent installations have been those of 45-, 60-, and 100-cord reinforced concrete kilns. The expanding production includes also substantial amounts of charcoal made in the several newly developed vertical batch and continuous equipment, utilizing both round and slabwood in short lengths and hogged or chipped material. Included as well should be the rather large additional amounts recovered by the now well-established method of continuous carbonization of wood fines. New plants operated by a continuous method of carbonization by force feeding of mill fines through a horizontal, multitube retort is expected to expand still more the production capacity of these newer facilities (27).

Lacking up-to-date surveys, it is not possible to give the extent of more recent charcoal production. An increase over production reported for 1956

may be safely assumed. This assumption is based largely on the construction of new kiln-type facilities reliably reported during the past 3 to 4 years. These facilities in 1956 accounted for upwards of 31 percent, or about 83,000 tons, of the total amount produced. Ninety-two percent of the raw material used in the charcoal industry was mainly medium to dense hardwood of such species as beech, birch, hard maple, hickory, and the oaks. The remaining raw material was chiefly pine. Of the total amount carbonized, about 74 percent was roundwood and the remainder slab and edging residues from primary wood-manufacturing plants.

There has been no direct information developed on the consumption of charcoal by end use within recent years. That it has varied use as a raw material is indicated by the many fields in which it has had commercial application (22). These uses are:

<u>Domestic and specialized fuel</u>	<u>Metallurgical</u>	<u>Chemical</u>
Recreational	Copper	Carbon disulfide
Curing tobacco	Brass	Calcium carbide
Cooking in dining cars and restaurants	Pig iron	Silicon carbide
Heating, foundry, and plumbing equipment	Steel	Sodium cyanide
Heating salamanders in ship-yards and citrus groves	Nickel	Potassium cyanide
	Aluminum	Carbon monoxide
	Electro manganese	Activated carbon
	Armor plate	Black powder
	Foundry molds	Plastics
		Fireworks
		Rubber
		Gas adsorbent
		Crayons
		Soil conditioner
		Pharmaceuticals
		Poultry and animal feeds

Recent reports indicate that little is used for producing a number of the items listed. For many uses, the amounts of charcoal commercially consumed are not generally known. Slightly under 100,000 tons were consumed industrially in 1956 in the Southern, Southeastern, and Great Lakes regions. An estimated 135,000 tons, or most of the charcoal briquetted and some in lump form, were consumed that year for outdoor and household recreational purposes and restaurant and railroad dining car cooking.

For many years substantial amounts of charcoal were used in metallurgy. This market has steadily declined, however, largely because of processing changes within the steel industry and substitution of cheaper carbon materials. There is little doubt, however, that recreational use has risen enough to offset the industrial loss (19). Approximately 35,000 tons of charcoal are used for tobacco curing, water purification, poultry and animal feeds, soil conditioning, and other miscellaneous uses.

While prospects for the increased use of charcoal in industry appear less favorable, particularly from a price standpoint, it may be that further developments in charcoal operations can lower costs enough to regain wider use in this field.

### General Production Costs

Kiln production costs vary widely, from about \$25 to \$60 a ton. Regardless of how these costs were determined, many different levels can be normally expected, because major cost factors do not affect costs of individual operations to the same extent (60,91). Among these factors are raw material and labor costs and the charges of original investment, depreciation, and plant maintenance. Additional but less important direct charges are there for insurance, taxes, and supervision.

Probably the most important single factor controlling the production cost and profit possibilities is the cost of the raw material at the kiln site. The extent of this cost is best judged on the basis that about 2-1/2 cords of medium dense wood are required to produce 1 ton of charcoal. It may easily represent, on the average, more than one-half the production cost. Mill slabs and edgings, therefore, usually offer better opportunities for profit than does forest wood. The average kiln-site cost of mill waste is at least one-third lower than the average cost of roundwood (4).

Labor charges are another major factor in production costs. These will differ with types of coaling equipment, mechanization, and other conditions at each operation. The important effect of labor charges on production cost is shown in results of two experimental studies (24,70,90) presented later in this report.

**Opportunities for minimizing the effect of both raw material and labor costs to give more spread between production cost and market price are improved with methods that make possible more efficient operation. Charcoal is a low-profit material. Therefore it is important to determine the minimum economic size of a unit capable of producing a volume sufficient to permit a predetermined net profit. Profit opportunities can be enhanced by mechanizing the handling of wood and charcoal to reduce labor costs, by obtaining larger charcoal yields, and by obtaining raw wood at the lowest possible price. So far as labor costs are concerned, it is generally true that more efficient production is possible if several units are used rather than one of equivalent overall capacity. There is, moreover, greater production flexibility with such an operation as market demands vary (11,16,28,29,69,70).**

**In general, operations of rather limited production should not seek outlets for charcoal in large bulk lots. The price usually received for charcoal sold in this manner is much lower than the price of the product when marketed in packages, and the outlets for lump charcoal, especially in carload lots, are not widespread. The operator desiring to develop and establish his own outlets by selling in package form can demand the higher prices and thereby increase his net profit (13). He must expect also, however, to give more time and effort to developing and maintaining these retail outlets.**

**The screened 3/4-inch to about 3-inch lump charcoal sold to recreational and domestic fuel markets is packaged in burlap bags, multiwall paper bags, or paperboard boxes. The burlap bags are usually of a 50-pound size and sold generally to various trade shops and industrial users. The commonly used paper containers for the recreational retail trade usually hold 2, 4, 5, 10, or 20 pounds. Cost of such packaging is estimated to be \$10 to \$15 per ton, which is more than made up, as a rule, by the better price the packaged charcoal commands.**

**For strictly bulk outlets, the producer may choose to briquette his product or sell it to a briquetting plant if this appears possible without excessive handling charges. The market price of charcoal delivered to the briquetting plant is \$35 to \$50 a ton. Returns somewhat greater than these are possible, however, since the fines fraction, normally screened out when bagging the lump product, is just as acceptable for briquetting as the lump. Production cost may be increased, in some cases, to provide temporary dry storage of the fines until a sufficient amount is stockpiled to pay for the hauling. The operator supplying charcoal to a briquetting plant may enter into a long-time contract that assures minimum holding time between production and transport.**

**The recreational market for charcoal is seasonal and reaches a peak during the warmer months. For this reason many producers stockpile sizable**

amounts, while others reduce or stop operations during the period of slack demand. Charcoal can be bulk stored without harm if it is off the ground and sheltered.

### Charcoal Markets and Marketing

All of the charcoal produced must be sold at a profit if an operation is to be successful. Because production costs, market demand, and the returns needed or considered desirable for each operation all differ widely, no one production pattern can be universally applied. To maintain production costs at reasonable levels and improve opportunities of profit requires alert and well-organized business management. Despite excellent overall demand, the prospects for reasonable returns from a given operation depend largely on operational conditions and markets available to the producer.

The lack of national marketing information handicaps production planning and organized marketing procedures. A number of surveys on charcoal consumption, use, and marketing pattern employed in general have been made by several State agencies for their specific areas (7,8,13,26,33,38,40,49,57,58,68,70,72,85,86,87,92). The marketing methods used are generally the same among the different States.

### Recreational and Industrial Outlets

Approximately one-third of domestic production is from small kilns and other types of coaling equipment of generally limited capacity (20). By product-recovery plants, including those converted entirely to charcoal, are of much greater capacity and are in better position, therefore, to supply the industrial bulk market and thereby establish general market prices. Briquette market prices (14,58,81) are not so strongly dominated by these producers. Prices quoted in market reports, however, usually become a selling base for both forms of charcoal. Market prices for recreational charcoal are not always uniform, probably because heavy local consumption and widely scattered markets result in prices established by local conditions of supply and demand.

Whether the prospective producer plans to sell charcoal locally or otherwise, he should first ascertain that there are market openings or that there is a good possibility for market development. Locating profitable outlets is often more difficult than producing the charcoal and must be considered equally important for successful operation. Before production is undertaken, therefore, it is good business to make a market survey of the area.

Well-established outlets for kiln charcoal include wholesalers and fuel dealers in cities and towns who buy sizable quantities for resale to industry, for packaging for domestic markets, or to plants manufacturing briquettes. Or the producer may sell bulk or packaged charcoal directly to local markets. When charcoal is sold to wholesale markets in bulk, returns will average from about \$55 to \$75 a ton delivered. Some wholesalers contract with the producer to do the packaging for an agreed-upon additional price.

The better outlets for the producer especially interested in establishing his own retail business are groceries, hardware and auto-supply stores, gasoline stations, and department stores. Since charcoal selling is a highly competitive business, such outlets demand systematic delivery of a well-packaged, quality product. Well-organized operations developed with such retail sale in mind can expect returns usually not much less than the range of \$80 to \$110 per ton for briquettes.

Other outlets for kiln charcoal may be available in areas where briquetting operations are expanding. The kiln operator may develop his own facilities for briquetting; or a ready-made customer for kiln charcoal may be found in a local briquetting plant; or local recovery plants with briquetting facilities, or even coal-briquetting plants, may be willing to expand their operations by purchasing kiln charcoal for briquetting.

### Charcoal Briquetting

The growing popularity of charcoal briquettes has spurred great interest among both large and small kiln operators. Some information on plant equipment and cost, manufacturing details, and the practicability of briquette production with kiln operations is briefly given to provide a few items of special interest (30,31,66,70,73,74).

Equipment. --The equipment required for briquette manufacture is highly specialized. Powered units are required for grinding and mixing dry and wet charcoal, wet forming the briquettes, moving material in process, and continuous drying (figs. 9, 10, 11, and 12). Production rates are 1 to 3-1/2 tons of briquettes per hour. The equipment for both capacities is basically the same, but somewhat larger and heavier machines are needed for the 3-1/2-ton output. Standard equipment for a 1-ton-per-hour briquetting plant includes the following:

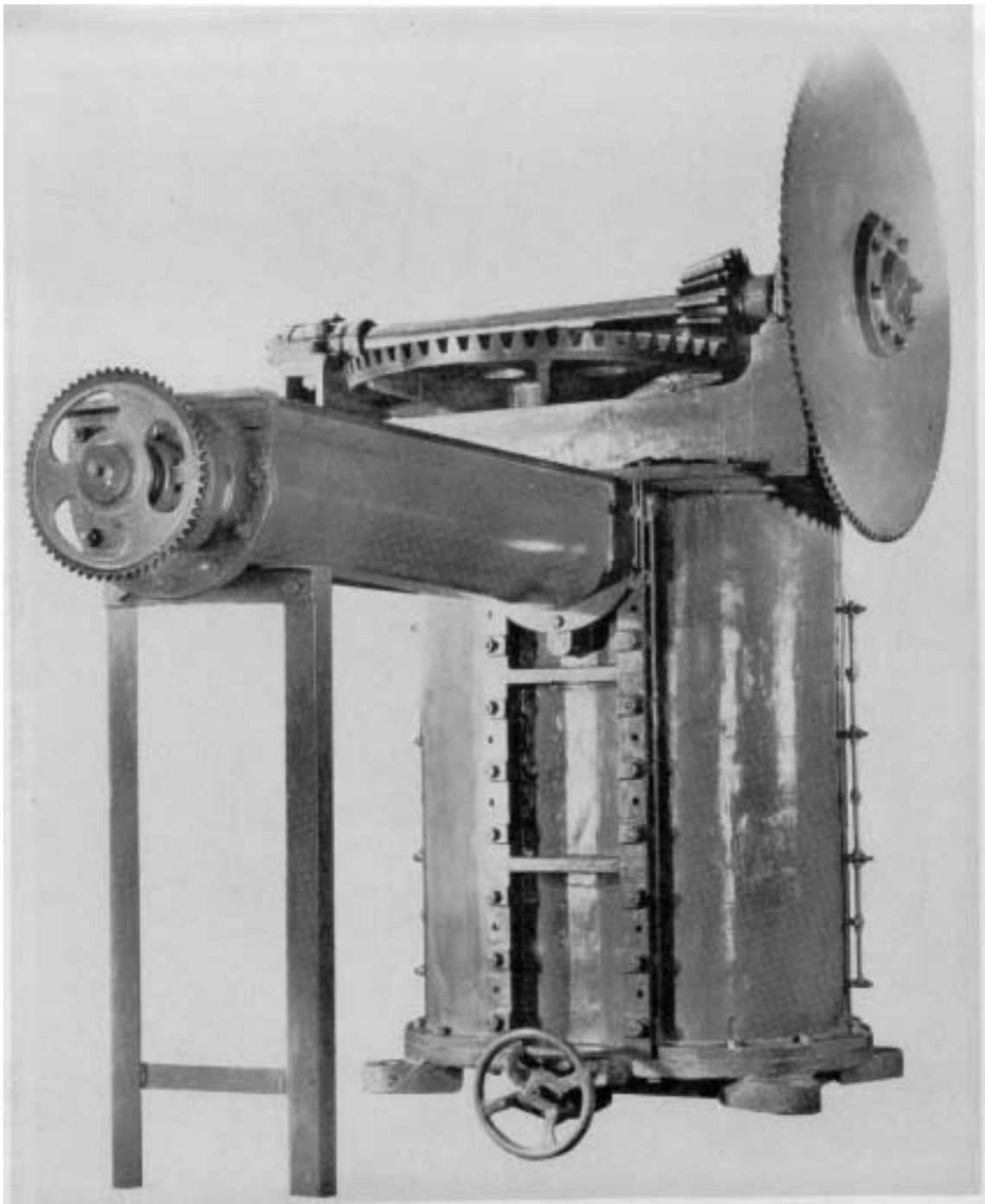

**Figure 9. --Two-shaft, vertical fluxer and paddle mixer.**

**ZM 116 910**



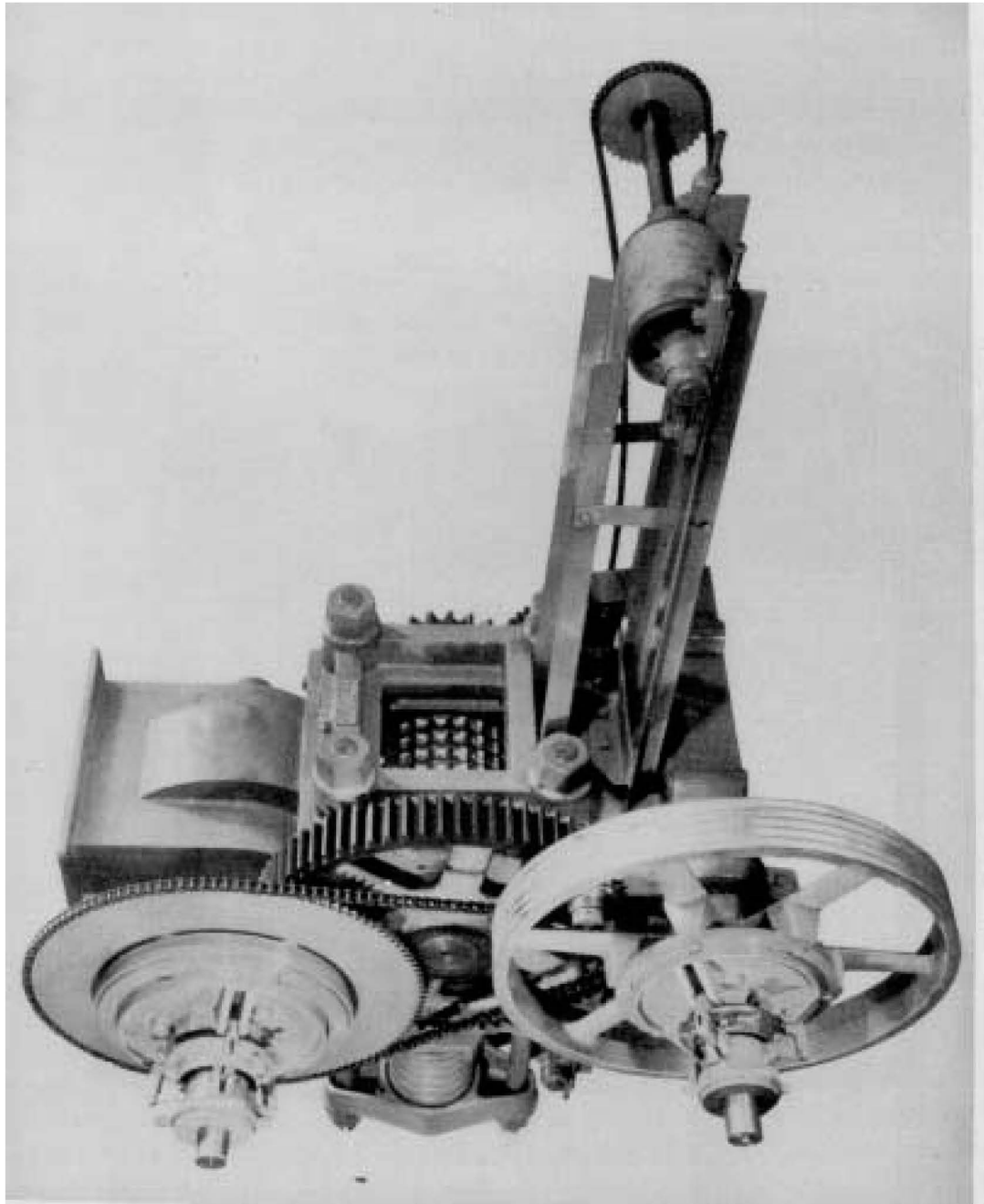

Figure 10. --Charcoal briquette press.

ZM 116 909

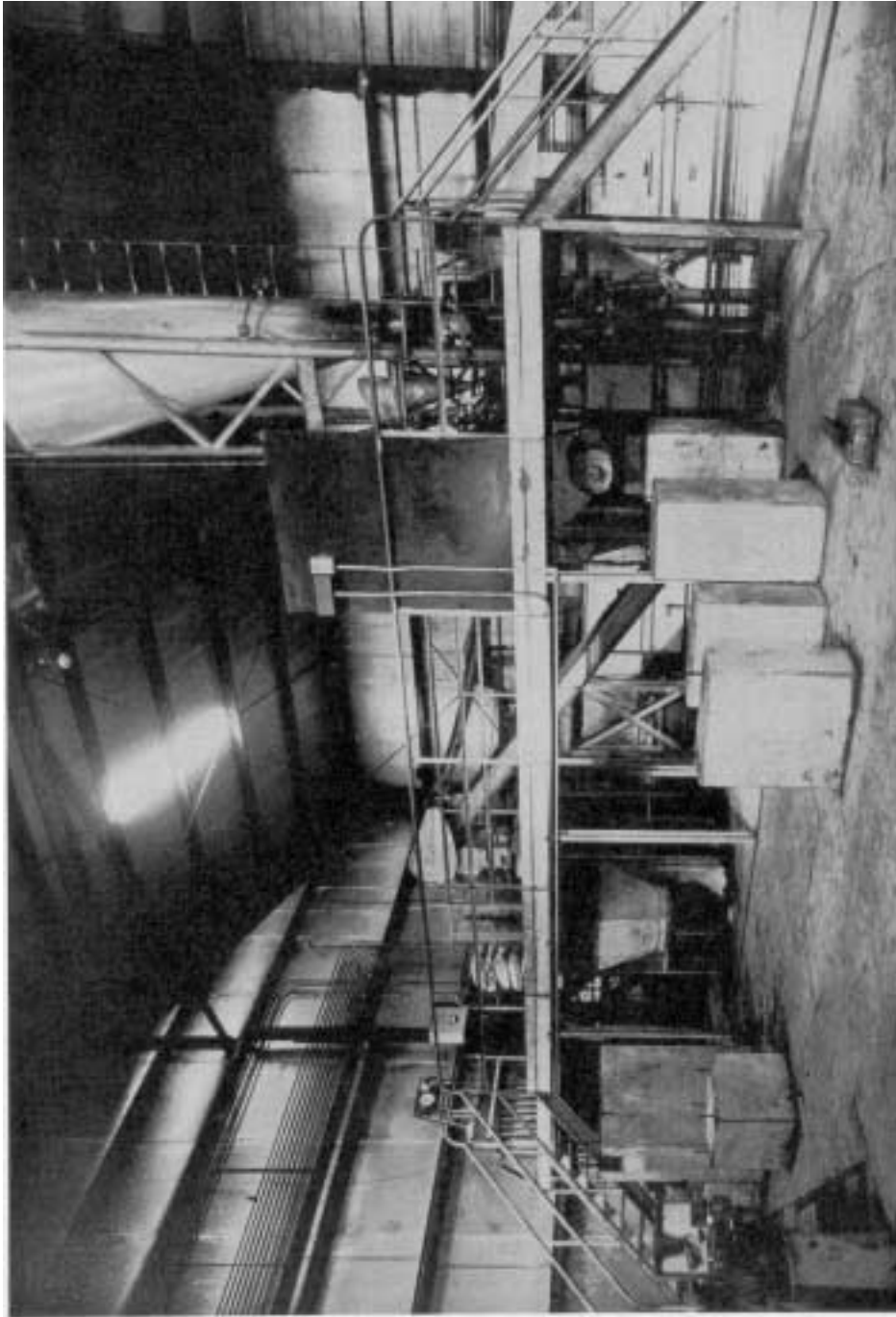

Figure 11. --Charcoal briquetting plant.

ZM 116 908



Figure 12. --Charcoal briquette drier.

ZM 116 907

**Briquette press with paddle feeder**

**Hammer mill**

**Charcoal feeder with surge hopper**

**Paddle mixer**

**Vertical fluxer**

**Starch feeder or pump**

**Briquette drier**

**Boiler, 30 horsepower - -15 pounds per square inch gage pressure**

**Conveyors**

**Bagging machine**

**Building, 60 feet by 120 feet, with 20 feet clear height.**

**The estimated investment for a 1-ton-per -hour plant is from \$150,000 to \$200,000. The further cost for an additional ton of briquettes per hour is about \$80,000. The labor requirements per shift are eight men, including a foreman, a machine operator, a night-shift maintenance man, a bagger, and three men for warehouse and miscellaneous jobs.**

**Plant processing. --In general, charcoal lump and fines as received or from plant storage are fed by screw conveyor to a hammer mill or crusher for feed material of 1/8-inch and smaller screen size. The ground charcoal is moved mechanically or by air to a surge bin for metered flow to the paddle mixer located directly below. As the material flows to the mixer, metered amounts of about 5 percent of binder (potato or cornstarch) with water are added. After agitation in a paddle mixer, the mixture is run through the fluxer for more thorough working of the mass before it is transferred to the press feeder for regulated flow to the forming press.**

**From the press, the wet or green briquettes are moved by belt conveyor to a special device for uniform loading and continuous passage through the drier. The conditions for drying are usually a 3- to 4-hour period at a temperature of about 275° F. The processing steps are carried out as shown in figure 13. The cost of producing briquettes, over and above the cost of making the charcoal, has been reported to be from \$20 to \$25 a ton.**

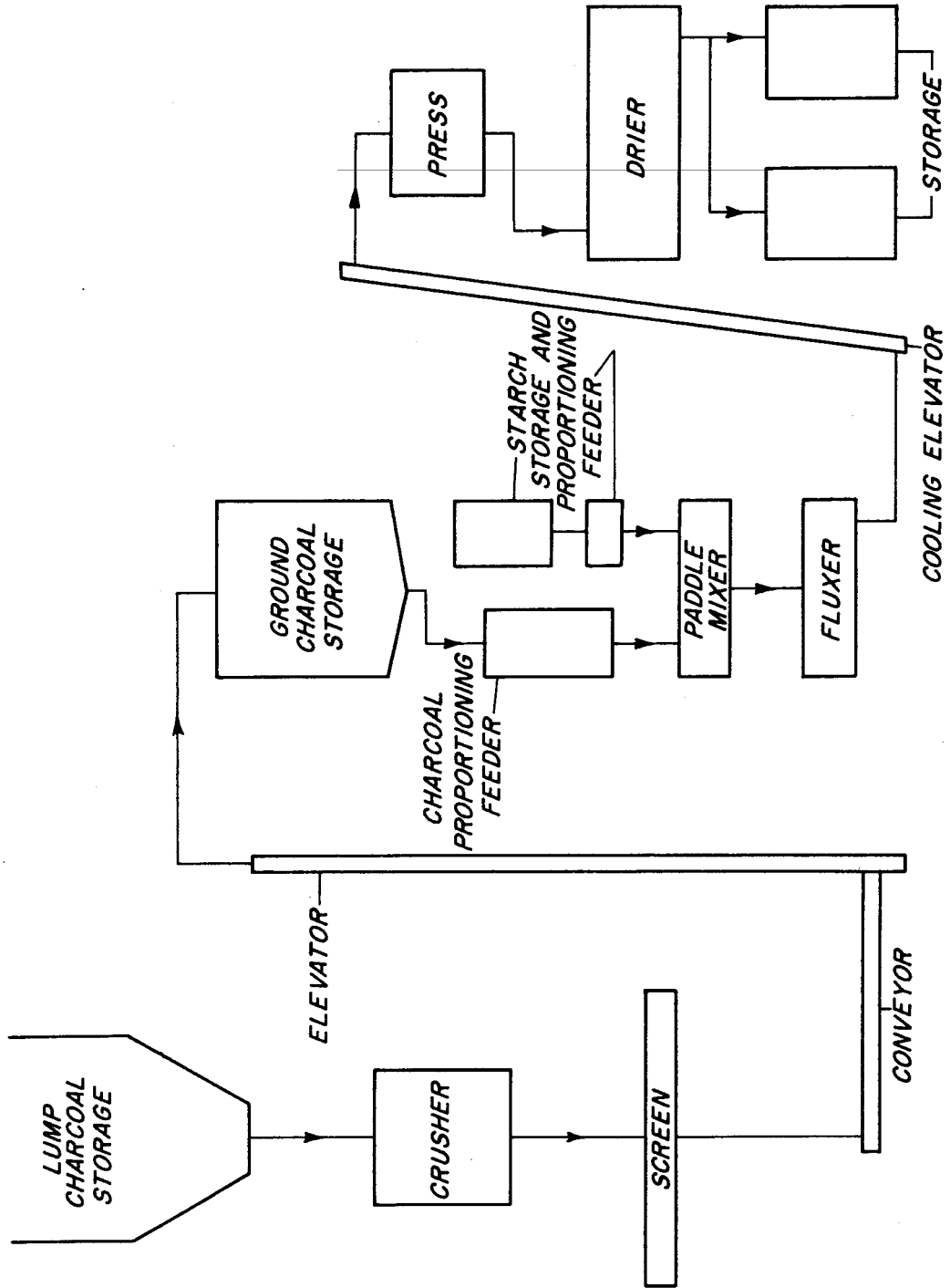

Z M 118 348 Figure 13. --Flow diagram of a commercial process for the manufacture of charcoal briquettes.

**Extent of briquette production.** --One important factor in charcoal production has been the increasing market for briquettes. This expansion has stimulated much interest in new kiln and briquetting plant construction. Since about 1951, the number of briquetting plants has increased from 5 to more than 40 (fig. 14) Some have been operated for years in connection with hardwood recovery operations. Others have more recently become part of other byproduct recovery operations, while a comparatively small number are part of coaling operations that are strictly neither kilns nor recovery-type plants.

The majority of the briquetting plants, however, utilize output of charcoal kilns. Additional briquetting plants have been reported under construction or in the planning stage. Most of the briquetting and kiln operations are in the eastern half of the country. Charcoal plants other than those of the kiln type are widely scattered. All have good sources of forest and mill raw material and market opportunities in areas of high population.

Because of the large daily charcoal requirements and the investment necessary for even the smallest commercial briquette operation, it is not practical for the smaller kiln operator to undertake such manufacture. Operating the smallest commercial plant at a production rate of about 10 tons of briquettes per day would require at least 250 tons of charcoal monthly. This would require, in turn between 550 and 600 cords of medium to dense hardwood material and indicates the size of the kiln operation that must be considered.

Briquetting plants usually operate on two or three shifts per day for most economical production. The opportunities for the smaller kiln operator in connection with briquette manufacture are probably most favorable when, with others or cooperatively, he can provide the level of production needed for such efficient briquetting plant operation.

**Transportation regulations.** --Precautions must be taken when transporting charcoal, especially for considerable distances and between States. The Interstate Commerce Commission has definite regulations concerning the movement of hazardous materials. The Commission lists charcoal among the flammable solids and oxidizing materials which are 'liable under conditions incident to transportation to cause fires through friction, through absorption of moisture, by spontaneous chemical changes, or as a result of retained heat from the manufacturing or processing.'

Properly cooled charcoal rarely displays such characteristics. The Interstate Commerce Commission has recognized the value of properly cooling charcoal, and the regulations (5) have been written accordingly. Specific examples are:

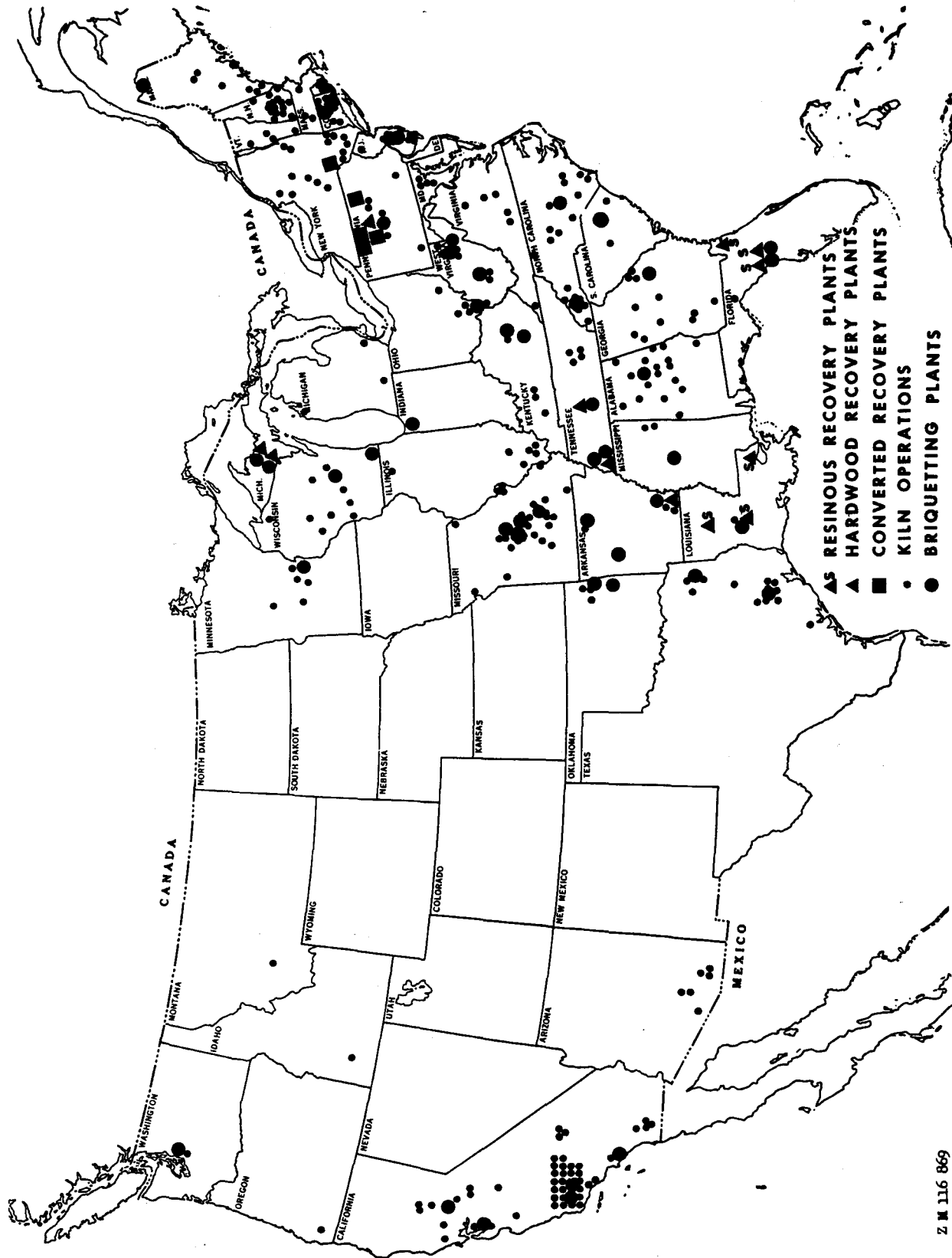

Figure 14. -- Distribution of briquetting plants with relation to kiln and other types of charcoal operations.

Z M 116 869

**"49 CFR 73.162 (j) (3) Charcoal burned in pits or kilns must be thoroughly cooled in the sealed kilns. After the kilns are opened, the charcoal must be allowed to stand in the open kiln or elsewhere exposed to the air for not less than 24 hours before loading into a freight car. Charcoal burned in kilns may be loaded in open cars or in boxcars, but after loading in boxcars, the cars must be allowed to stand not less than 24 hours with doors open before shipment.**

**"49 CFR 73.162 (k) (3) Screenings, or ground, crushed, granulated, or pulverized charcoal, from pit or kiln burned charcoal, are considered as non-hazardous, provided the screenings or the material from which the ground charcoal is made has been exposed to the air for not less than 5 days prior to shipment or grinding."**

**There are additional regulations covering practically all parts of the transportation phase of the industry. These include packaging and marking; drying specifications for briquettes before transport; handling of lump charcoal and screenings; and instructions for loading boxcars, motor, and other carriers. The regulations further prescribe the handling of charcoal. For example, Sec. 77.838 (b) (3) states:**

**"Articles to be kept dry. Special care shall be taken in the loading of any motor vehicle with flammable solids or oxidizing materials which are likely to become hazardous to transport when wet, to keep them from being wetted during the loading process and to keep them dry during transit. Examples of such dangerous materials are charcoal screenings, ground, crushed or pulverized charcoal, and lump charcoal."**

**The sections noted here are but a few of the regulations covering the handling and transport of charcoal. Persons interested in producing charcoal should consult an Interstate Commerce Commission representative. These representatives can be located by inquiring of the local postmaster.**

## **FOREST SERVICE RESEARCH**

### **Scope of Program**

#### **Purpose of Research**

**Forest Products Laboratory research dealing with wood carbonization was in its earlier phase directed primarily toward problems concerned with byproduct-recovery plant practice. More recently, its object has been the development of methods for the continuous distillation of wood fines. Before**



1954, some limited work was carried out elsewhere than in the Forest Service on methods of kiln carbonization. The investigators conducting much of the early work in this field were H. W. Hicock and associates, who experimented directly with small masonry-block kilns in Connecticut, and H. H. Tryon, who studied the operation of small portable sheet-metal units in New York State.

Beginning about 1951, the demand for charcoal as recreational fuel indicated a much larger production was needed. Because of increasing public interest, the Forest Service observed many charcoal operations in different parts of the country to determine if further research would be helpful, and if so, in what manner and to what extent it might be best undertaken (6).

It was generally agreed that research was needed, especially for the greater utilization of low-grade forest wood and mill residues, and that no agencies were currently making studies in this field. It was concluded further work might well be directed toward the adaptability and use of masonry-block structures in the range of 3- to about 10-cord capacity. The investigations undertaken were aimed, therefore, toward the following objectives:

1. Develop a suitable low-cost, masonry-block kiln.
2. Develop reproducible operational procedures designed to provide maximum yields.
3. Determine the economics of kiln operation with variables of wood species, wood type and form, and moisture content.
4. Develop kiln mechanization methods designed to minimize labor costs.

The work undertaken about 1955 included the design and field operation of 12 experimental kilns. These kilns, of 3 to 10 cords in capacity, were located in Colledgeville, Minn.; Three Lakes, Wis.; Milwaukee, Wis.; Marquette, Mich.; Elizabethtown, N. C.; and Athens, Ga.

This research was conducted cooperatively by the Forest Products Laboratory and two Forest Experiment Stations, together with colleges, universities, State forestry commissions, and industry (46).

### Types of Experimental Structures

Single-wall, concrete masonry kilns. --Initial investigations were conducted on three single-wall, masonry-block kilns of a rectangular shape. Kiln dimensions were designed to accommodate both 4- and 5-foot wood. Inside

dimensions were about 8.7 feet wide by 18.7 feet long by 7.3 feet high at the ceiling height. Capacity was about 7 cords net, based on a 4- by 4- by 8-foot cord.

These initial 'I-cord units were located at St. John's University, Collegeville, Minn. (fig. 15), on the Argonne Experimental Forest in Wisconsin and at the Athens, Ga. Research Center of the Southeastern Forest Experiment Station. A smaller 2-cord, masonry-block unit was located on the Bladen Lakes State Forest in North Carolina.

Concrete masonry was selected as the type of construction best suited for these small-size kilns because of general availability, ease of assembly, economy, and durability of the masonry units. Cinder-concrete masonry was specified as the basic wall material because of its proven fire resistance and durability in commercial kilns. Some masonry units with expanded blast-furnace slag (Waylite) were used in one of the kilns where crushed and screened cinders were not available.

These experimental kilns differed in several ways from the original 1- and 2-cord, masonry-block kilns designed and investigated by Hicock and associates. They were much larger, and each had a steel ceiling. Several had a metal door that was either suspended from the top or hinged at the sides.

These 7-cord kilns had one or more control joints in the length of a side wall and at one or both rear corners. Each control joint was reinforced by a free-standing pilaster of masonry block against which air leaks (indicated by escaping smoke during coaling) could be sealed off with a cement or lime paste whenever needed. These control joints were intended to limit the length of wall sections between expansion joints and thereby minimize the amount of expansion and contraction and subsequent vertical fractures normally occurring in such walls. Some of these wall sections were provided with metal-lath joint reinforcement in all or in alternate courses in a further attempt to prevent the customary vertical fracture of units.

Some fractures or cracking developed in spite of these preventive measures, more especially in the blocks made from expanded blast-furnace slag, but with far less frequency in the cinder-concrete units. Joint reinforcement was of questionable help in these short 9-foot sections built of an expanded slag block. It may have been of some help in the cinder-concrete walls, but this was hard to tell. Nine-foot-long walls of cinder concrete having wire-mesh joint reinforcement had narrower and fewer cracks than the reinforced 9-foot sections of slag-type block. Some of this difference could be attributable to a difference in operating temperatures. It was more likely due, however, to the fact that the thermal expansion of cinder concrete is only about one-half that of concrete masonry made from expanded slag-type



**Figure 15. --Experimental single-wall, masonry block kiln.**

**ZM 100 144**

aggregates. It nevertheless served to indicate the superiority of cinder over slag aggregates for kiln blocks. The thermal expansion of natural sand and gravel blocks may be slightly greater than that of slag-type units unless the former are made from a limestone aggregate.

The first single-wall structure built with control joints at the midpoint of each side wall and at the rear corners is still operable after 50 runs (fig. 15). Repairs were made, however, after the first 25 runs to replace the front one-half of one side wall, made of sand-lime brick, with Chicago common brick, and to replace the rear corner pilasters. These corner pilasters had been forced outward at the top by the gradual seepage of sand from the ceiling cover into the vertical joint. Extensive sealing of the outside wall surfaces with a lime paste kept these brick and cinder-concrete walls in good working order. Because of difficulty in maintaining a tight seal between walls and pilasters, it seemed preferable to omit control joints and pilasters, and instead to shorten the length of side walls.

Double- or composite-wall kilns. -- The considerable expansion and resultant cracking of the long side walls in the rectangular kilns, together with the need for continued maintenance in keeping the walls tightly sealed, led to experiments with two square-shaped, double-wall kilns. Interiors were 12.7 feet wide, 13.3 feet long, and 7.3 feet high. The square shape provided the same 7-cord capacity while shortening the length of the side walls and thereby reducing the total amount of linear expansion per wall. Instead of one 8-inch wall, the wall now consisted of two 8-inch walls with an 8-inch column of sand in between (18). The fine, dry sand was expected to seal off any small cracks as they developed and thus eliminate the need of continual outer-wall maintenance.

Another important difference between the earlier rectangular kilns and the later square kilns was the use of air entry at the front of the kiln only.

These square kilns were located at the Athens Research Center in Georgia (fig. 16) and on the Dukes Forest in Upper Michigan (fig. 17).

Both of these kilns were operated continuously for about 11 runs before any important structural change became noticeable. Inner walls had expanded and had begun to bow inward from 1 to 2 inches along the top at midlength of the side walls. With further use and subsequent settlement, the non-compressible sand-fill pressures became great enough after about 21 runs to force the outer side walls outward and cause step-pattern breaks in them in the vicinity of the rear corners. While these breaks were as much as 1/2 inch or more near the top and 1/16 inch or less at the bottom, they were repairable. Such breaks served to bring out the chief weakness of this type of construction.



**Figure 16. --Experimental double-wall, masonry block kiln with multiple chimneys and single, front air entry.**

**ZM 100 779**



**Figure 17. - - Experimental double-wall, masonry block kiln with multiple chimneys and single, front air entry.**

**ZM 112 349**

**One inner wall that had bowed inward about 2 inches at the top at midlength was removed and replaced with new material after run 22. After 14 additional runs, this portion of the new wall had again bowed inward, so that the top of the wall at midlength was 2-1/2 inches out of plumb with respect to the bottom. It cannot be predicted how much inward bowing and tipping of walls can be tolerated without danger of sudden collapse.**

**If the sand fill is to remain dry enough to act as a sealer of the outer wall, it will continue to settle and to force the double walls farther and farther apart. It is doubtful that such sand-filled structures will ever reach the point of stabilization where wall maintenance is no longer required.**

**The inner wall of a double-wall masonry kiln will probably expand more during a coaling period than a single wall of the same material, because of more uniform heating throughout the inner -wall blocks. The outer surface of a single wall is being continually cooled by normal air circulation, and the net thermal expansion of such a wall is consequently less. Thus, the deformation of single-wall structures, which 'permit greater heat loss, should be less than that of similar inner walls of a double-wall structure.**

**If inner walls of double-wall kilns were made of brick, however, their net expansion would be no greater than that of a single wall of concrete masonry, because the thermal expansion of brick is only about one-half that of sand and gravel masonry. When an inner shell of brick is used, the self-sealing features of a dry sand fill can probably be tolerated if the resulting reduction in daily maintenance to the outer walls will offset the extra expense of the periodic replacement of the inner walls.**

**A number of such 14-cord, double-wall, rectangular kilns have recently been built by commercial operators. Some of these kilns have been in service for over 2 years. Each kiln has 14- to 16-inch walls and is approximately 25 feet long by 15 feet wide by 9 feet high. Kiln walls consisted of 8-inch (sand and gravel) masonry-block outer walls with joint reinforcement between alternate courses, 2 to 4 inches of sand fill, and an inner wall of brick or 4-inch masonry block (slag-type aggregate). Fire brick was sometimes used for the lower 40 inches of the inner walls, and 4- by 8- by 16-inch slag-type masonry block or common brick was used on the upper portion. Outer and inner walls were held together by bolts and vertical bars inside and outside, spaced on about 4- to 5-foot centers.**

**These 16-inch walls are also being damaged by the expansion forces against the noncompressible sand fill, but to a lesser degree than the 24-inch walls. Damage and breakup is usually confined to the upper common brick or Way-lite portion of the inner walls after 4 to 5 months of use without causing any extensive damage to the heavier outer walls of 8-inch masonry. It would**

appear that such 16-inch walls should be more economical to build and repair than 24-inch walls. They have the further advantage of retaining the sand-sealing feature of the heavier, double-wall, experimental structures.

A few smaller double-wall kilns of 2- to 3-cord capacity were also included among the experimental structures (44,47). A 2-cord, double-wall, masonry kiln with separate or independent roof and ceiling supports is shown in figure 18.

Another 2-cord kiln of double-wall masonry construction is shown in figure 19. In this demonstration kiln a 4-inch space was provided between 8-inch masonry walls that was filled with expanded mica. A slag-type aggregate of processed blast-furnace slag was used in the concrete masonry block. The mica material was of the 'home insulation-pellet grade. It was sufficiently fine to prevent channeling of flame from any lower breaks in the masonry, but not so fine as to flow into cracks and act as a sealant, as does fine, dry sand. In fact, the chief advantage to be gained was that of independent action of each of the walls. Another advantage was better insulation and the confinement of heat for coaling, with resulting saving of fuel. It was further believed that the insulating effect of the fill would reduce exterior wall expansion and thus permit use, for the outer walls, of the more common masonry block made from sand and gravel aggregate. Blocks of a lightweight aggregate that are more resistant to heat than rock-aggregate blocks should preferably be used for the inner walls, however.

It is particularly important to provide a tight seal at the top of any such granular fill to prevent ceiling sand from sifting into the cavity and eventually filling it, thus creating a condition presently objectionable in the double-wall, sand-fill kiln. Either the ceiling steel must be extended over the opening and over about one-half of the outer wall thickness, or preferably a separate sheet-metal strip can be added to cover the fill area. A 2-cord commercial kiln similar to the demonstration kiln pictured in figure 19 has performed satisfactorily for about 20 runs. It is expected that the expanded mica fill will pack down in time and leave an uninsulated space at the top between walls.

**Refractory construction.** - - One 3-cord, experimental kiln was made with composite walls of 8-inch, cinder-concrete block lined with a 3-inch thickness of a castable, high-temperature refractory material (fig. 20). The back-wall refractory is rated to withstand a temperature of 2,700° F. and the side walls 1,500° F. The composite walls are held together with metal wall anchors placed in the wet mortar of the masonry wall as it was built. Inside forms were erected and a 3-inch thickness of refractory material was poured and rodded into place against the masonry walls. The ceiling was a 6-inch thickness of castable refractory material rated to withstand a temperature of





**Figure 18. --Experimental 2-cord, double-wall, masonry block kiln with one chimney and single, front air entry.**

**ZM 112 313**



**Figure 19.- -Experimental 2-cord, double-wall, masonry block kiln with three chimneys and single, front air entry.**

**ZM 114 310**

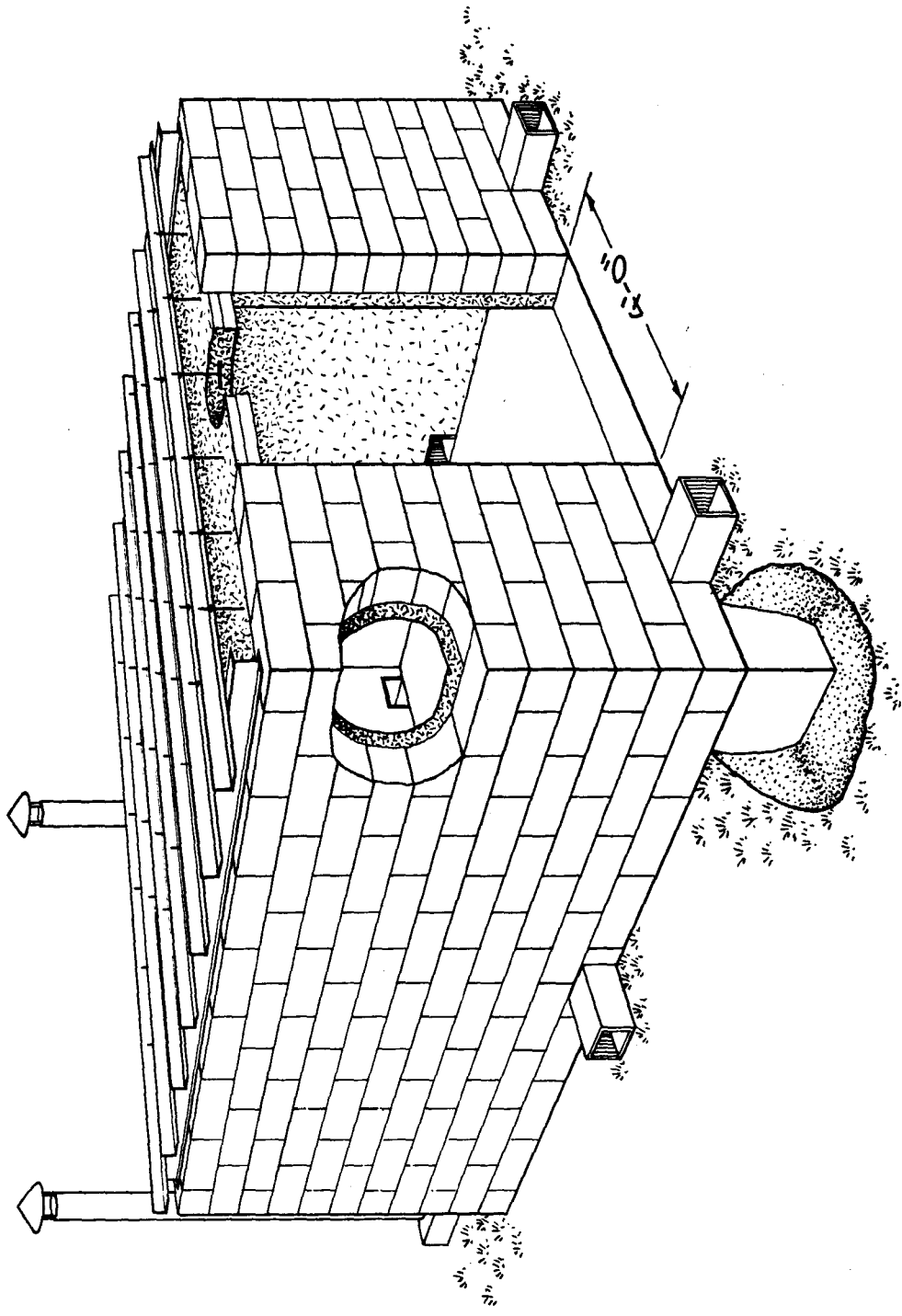

Z M 118 345

Figure 20. -- A 3-cord cinder block kiln lined with a castable refractory material.

**2,300° F. It is supported by means of metal anchors cast into the refractory material and fastened to rods suspended from angle irons spanning the side walls.**

**One-fourth-inch-wide shrinkage cracks developed in the back corners of the refractory lining during the curing period, together with many smaller cracks on both inside and outside walls. Castable refractory linings shrink considerably upon initial drying, so expansion joints are recommended at the corners of rectangular shapes. Inside cracks were repaired with the refractory-type material. Outside wall cracks and the entire ceiling were sealed with an asphalt-asbestos sealer that, when hot, is pliable and nonrunning. Only nine runs had been made in this kiln when this report was prepared. All initial repairs remained intact, and the ceiling was serviceable without a roof covering. The chief advantage of using a refractory lining is in its slower disintegration at elevated temperatures.**

**Corrugated sheet-metal kilns --Corrugated sheet metal was used as a wall material in two 3-cord, double-wall kilns on the Argonne Forest. It was first tried in both walls and then in one wall in combination with cinder-concrete masonry, as pictured in figure 21. The essential design features of these two double-wall kilns with separate roof and ceiling supports are shown in figure 22.**

**In section A, figure 21, two walls of corrugated sheet metal are shown positioned about 7 inches apart. A 3-inch thickness of a rigid sheet-type, mineral-wool insulation was placed against the outside metal wall, and the remaining space was filled with dry sand. The inside metal wall was supported on 2-inch-diameter pipe frames. The outside metal wall was supported by means of 4- by 4-inch wooden posts used also to support a shed-type roof giving protection from the weather.**

**In section B, figure 21, an inner wall of 8-inch, cinder-concrete masonry is shown combined with an outer wall of corrugated sheet metal, supported by wooden posts as in section A and with a 6-inch fill of dry sand between. In each case, the ceiling was of 18-gage metal supported on 2-inch pipe, with each pipe suspended from the rafter members of the shed roof by means of 3/8-inch rods.**

**For the first few runs, the door of the kiln shown in section A was of sheet metal with a sand fill between the metal and rigid insulation, held in place by removable boards running crosswise into vertical side guides. A steel door and a laid-up block door were used. A masonry door of 12-inch, cinder-concrete blocks laid up dry was used for the kiln shown in section B, figure 21.**



**Figure 21. - Experimental 3-cord, double-wall kilns.**

**ZM 112 348**

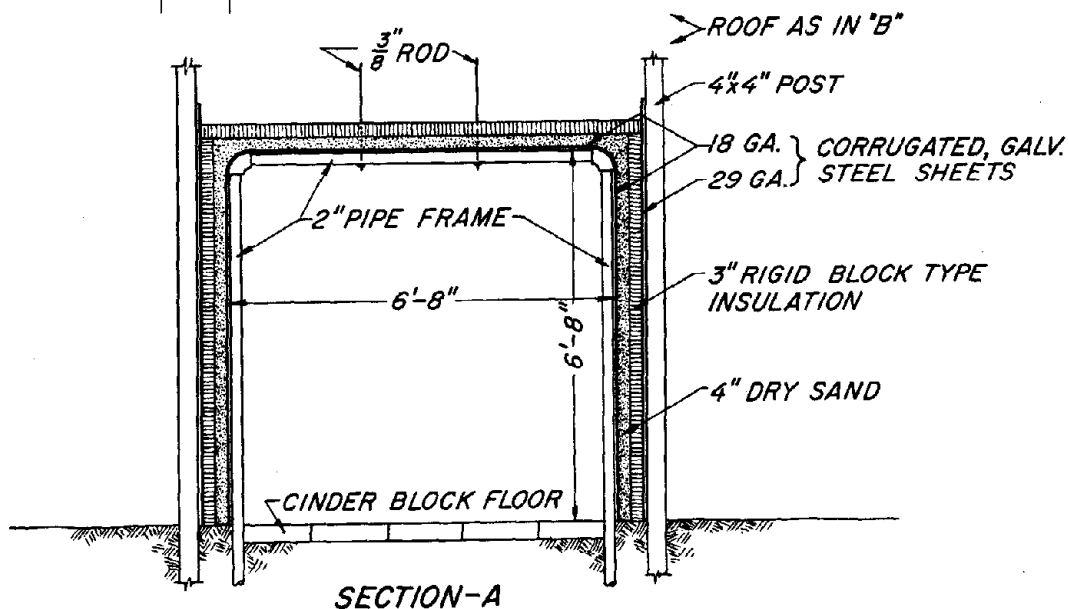
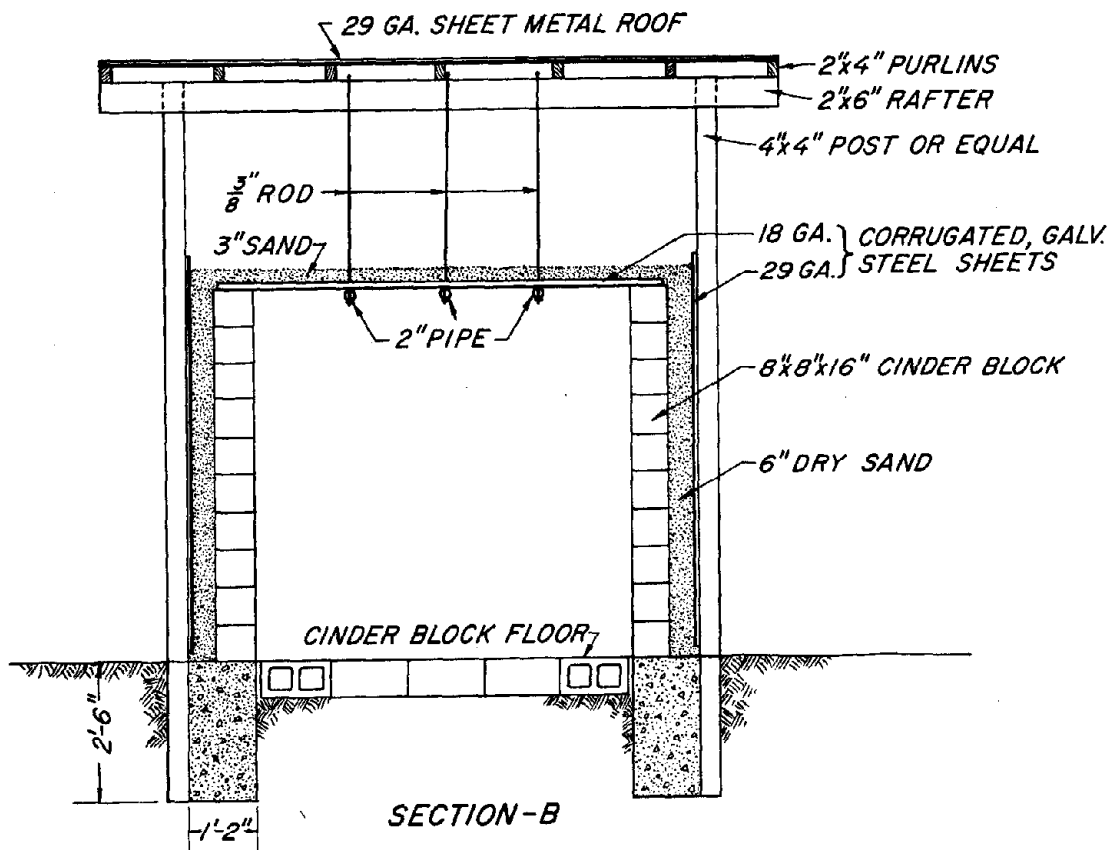

Z H 118 343

**Figure 22. -- Experimental double-wall kilns with one or both walls of corrugated sheet steel.**

The behavior of the sand-filled walls in the kiln shown in section B was similar to that of the larger, double-walled, masonry-type kilns described earlier. One masonry side wall bowed inward near its top front and was about 1-1/2 inches out of plumb.

The bowing of masonry walls caused by the natural expansion of the material and pressure exerted during settlement of the sand fill and subsequent increase in sand thickness also caused a considerable outward bowing of the 4- by 4-inch supporting posts. These posts, each anchored in the ground and held at the top by the roof rafters, were expected to break eventually and would have to be replaced. At that time, the sand fill would also have to be removed and outer metal walls repaired or replaced as required. Some corrosion was visible outside along the lapped edges of the galvanized, corrugated, sheet-metal walls from the action of acidic vapors from the wood that seeped through cracks in the inner cinder-block wall. In other respects, these cinder-concrete walls were, in good condition after 36 runs.

The performance of the double-wall, sheet-metal kiln shown in section A, figure 21, was satisfactory through 16 runs. There was no apparent bowing of walls or supporting posts. One lower lap joint of sheet metal on an inner wall buckled slightly by bowing between the vertical pipe supports because of excessive temperatures during experimental work. A wider overlapping of the sheet-metal joints or a closer spacing of supports was believed needed.

### Structural Requirements of a Concrete Masonry Kiln

#### Size and Shape

Following the choice of a suitable location for the kiln, the next step is to determine its size and shape. The size, or gross capacity, is dependent on certain factors: (1) Estimated weekly or monthly volume of raw material to be coaled, (2) size of the material, such as chunk or short-length wood, 4- or 5-foot roundwood, longer slabs, and other mill residues. Masonry-type kilns larger than 10-cord have been built, but are not recommended because of the considerable expansion of any type of concrete masonry construction at carbonizing temperature.

Walls should be limited to 18 feet in length, because even cinder-type masonry, which expands far less than other types of concrete masonry, will expand as much as 1/2 inch in 18 feet at the normal 800° to 900° F. coaling temperatures. The kiln length will be governed largely by the length of one or a number of wood lengths plus about an 18-inch space for ignition fuel. Actual dimensions must, of course, fit requirements of the masonry block

to be used, so that only full and half-size blocks need be used, and that none need be cut on the site. In other words, build to an 8-inch unit of measurement.

The height of the kiln walls will be governed by several factors: (1) By the 8-inch dimension of the blocks; (2) by the clearance required for mechanized handling equipment, such as front-end loaders; or (3) by the practical height to which loading can be done by hand. Masonry blocks will increase in height as well as in thickness and length when heated. The greater the wall height, the greater will be the tendency for walls to bow outward and develop a distress in horizontal joints. It is good practice to limit height of walls to 6.7 to 7.3 feet.

The shape may be square or rectangular, depending upon the size limitations of the construction materials and the wood length.

A single-wall kiln of about the maximum recommended size, suitable for both 4- and 5-foot wood and one- or three-stack operation, is shown in figure 23. Many of the most favorable details of construction from the experimental kilns have been combined as shown. The structure consists of 8- by 8- by 16-inch cinder-concrete-block walls with three reinforcing bands of lintel-type block, erected on a perimeter-type reinforced concrete footing; a steel ceiling supported on the side walls; and a suspended sliding-type steel door.

### Materials of Construction

Masonry blocks composed of both coarse and fine aggregates of crushed and screened cinders from bituminous coal clinkers are recommended as the basic wall material. Expanded blast-furnace slag may have to be used when cinder aggregates are not available. All such blocks, however, must be of the highest possible quality or they will prove unsatisfactory. Dense, moist-cured, cinder-concrete blocks are preferred because of their lesser expansion and their proven durability not only in experimental but also in commercial-type kilns.

Masonry units are usually described by their nominal dimensions; that is, an 8- by 8- by 16-inch unit, an 8- by 12- by 16-inch unit, and so on. A 16-inch unit is actually only 15-5/8 inches long. The difference between the 15-5/8 and 16-inch length is taken up by the 3/8-inch mortar joint necessary to maintain the 8-inch unit of measure. Standard full-size and half-size units in regular or stretcher-type blocks, together with a few corner blocks, pier or double -corner, and lintel-type blocks will be needed. Standard blocks by



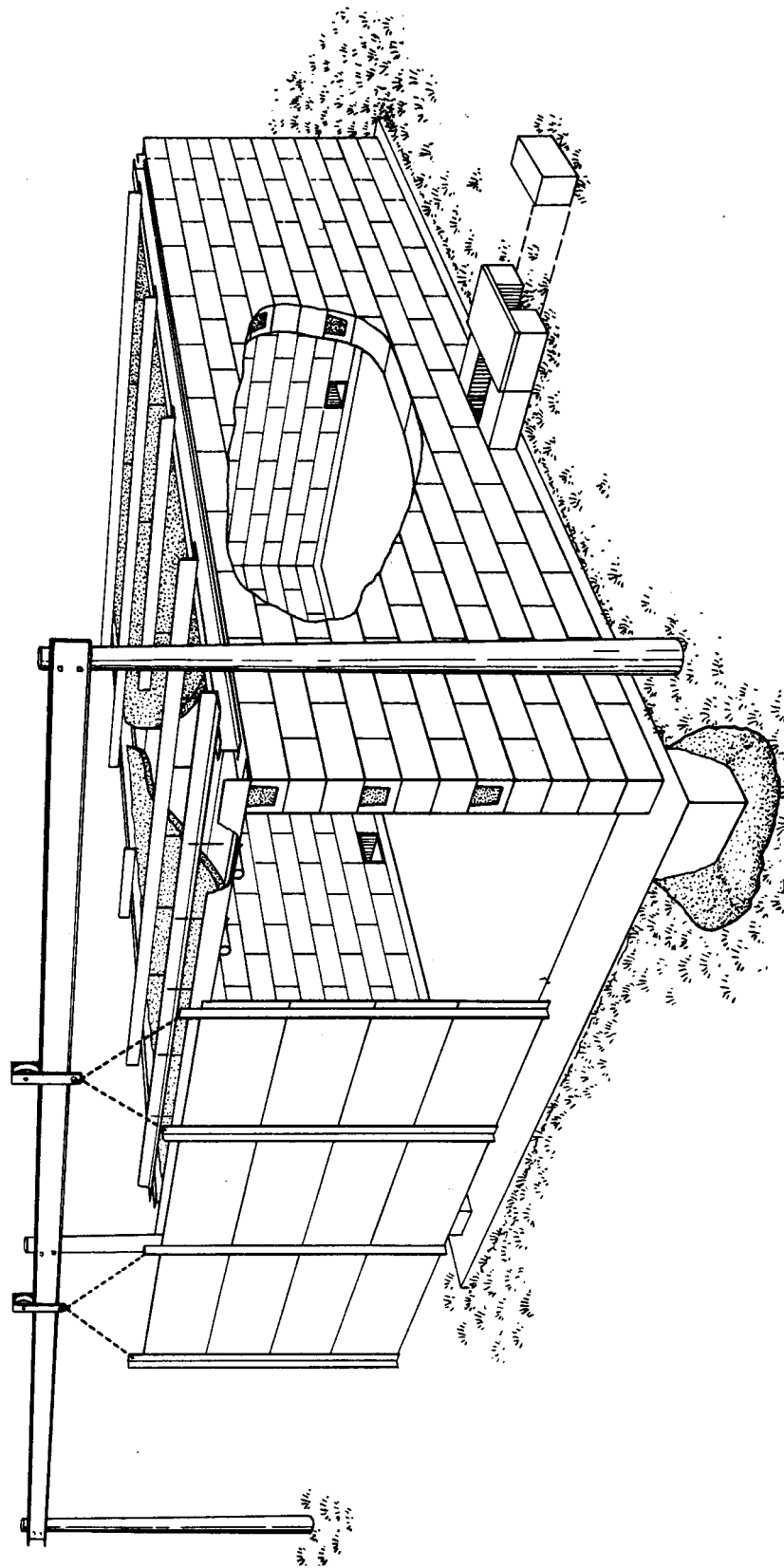

Figure 23. ---A single-wall, masonry block kiln of 7-cord capacity.

Z M 118 346

different manufacturers may vary in size and in shape and arrangement of cores, and even in the name given each unit. A few typical masonry units are shown in figure 24.

Lintel-type blocks with reinforcing bars in poured concrete should be used in at least three courses in each kiln, as shown in figure 23.

A good grade of masonry mortar with two parts of mortar sand should be used, or a mix consisting of 1 volume of Portland cement, 1 volume of lime putty or hydrated lime, and 6 volumes of damp, loose mortar sand.

Eighteen-gage, corrugated, sheet-metal roofing or 18-gage, tri-rib steel decking is recommended for the ceiling.

Sixteen- to 14-gage, hot-rolled steel sheet or galvanized 18-gage, corrugated sheet metal is recommended for the steel &or.

Reinforced concrete in the footings and lintel-block reinforcing bands may be ready-mixed concrete or a 1:2:4 batch-type mix of 1 part of Portland cement; 2 parts of clean, sharp sand; and 4 parts of rock aggregate.

### Construction Details

Footings. --Masonry-type kiln walls should be supported by a continuous perimeter-type reinforced concrete footing. The footing should extend at least 8 inches below the surface of well-drained ground. If only intermittent winter operation is planned in areas where the ground freezes, the footing should extend below the frostline. If continuous winter operation is planned or if frost seldom or never occurs, a minimum footing depth of 8 inches may be used. The footing shown in figure 23 is 12 inches deep and 16 inches wide, with the portion across the front extending 8 inches beyond the front end of the side walls. Place two No. 4 (1/2-inch round) reinforcing bars about 8 inches apart in each of the four sides, making sure to overlap the bars at the four corners. If the footing must extend deeper than 12 inches because of frost, limit the width to 12 inches and keep the outside edge flush with the outside face of the side and rear end walls, but keep the 8-inch extension beyond walls across the front end.

Before starting to excavate the footing trench, square the corners by making sure that the distances between diagonally opposite corner stakes are equal. Then, where the soil is firm enough to serve as a trench, form only the top 3 or 4 inches to help in striking off the top of the concrete to obtain a level surface at the top of the footing.

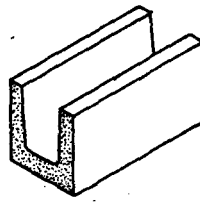

*LINTEL*

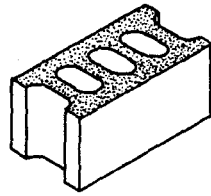

*STRETCHER*

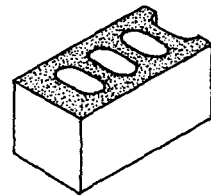
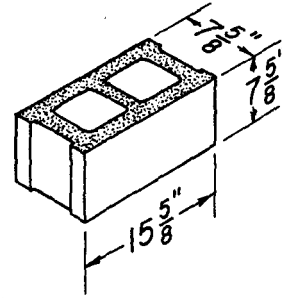

*CORNER*

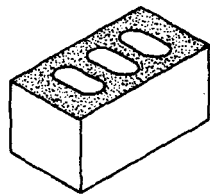
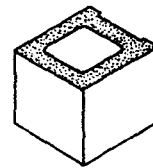

*PIER*

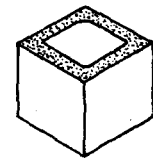

Z M 118 344

**Figure 24. - - Typical masonry units for block-type charcoal kilns.**

**Do not build kiln walls on a floating-type floor slab. If a concrete floor slab is desired, it should be poured separately from the wall footing. Be sure to have at least a 1/2-inch space between the floor slab and the edge of the footing to allow for expansion of the slab. Concrete is almost sure to spall, so the slab should be provided with a wire mesh reinforcement placed near the surface of the slab to hold any spalled pieces in place. If not of concrete, the floor of the kiln may be of earth, brick, masonry block, steel mats, or other noncombustible material.**

**Do not pour concrete on frozen ground. If the footing is poured in cold weather, heat the water, sand, and aggregate before mixing, and protect the green concrete from freezing for at least 72 hours.**

**Walls.- It is very important that the first course of blocks be carefully laid in a full bed of mortar. If the base and second courses are accurately laid, the balance of the blocks will go into place with all joints perfectly broken. All blocks are laid with the hollow cores vertical. If hollow-core blocks are used in the top course, all cores must be filled with mortar to prevent channeling of air into the kiln through cracks that might develop on the inner wall surface.**

**Neat cement or the standard 1:3 mix of cement and sand may be used to level off the tops of the front wall blocks over which the bottom of the angle-iron lintel must rest in order to seal off the ceiling cover with sand. A piece of bright sheet metal may also be used between the angle lintel and the top of the wall to permit the lintel to slide more easily along the top of the wall. A loose brick may be used to retain the sand at the end of the lintel.**

**One to two courses of brick are commonly laid around the top edge of the kiln to act as a coping. The purpose of the coping is to help prevent the ceiling sand from being washed and blown off the ceiling steel. Sections of steel rails or I-beams can serve (fig. 23) both as a coping material and as a support for the ceiling beams. They also distribute the weight of the ceiling beams along the side walls and restrain the walls from bowing outward at the top.**

**Good workmanship is very important when laying the walls. If an experienced mason is not available, some good manual of recommended practices should be consulted before attempting to lay any block (1, 2). Such publications will provide dimensions of the various types of blocks, recommended mortar mixes, and many helpful suggestions for building a good wall.**

**All mortar joints must be carefully compressed and left neat and compact, either in a concave or V-shape. Such joints will provide a good valley for sealer compound as sealing becomes necessary during operation. Other types of mortar joints are not recommended.**

Immediately after construction, apply a brush coat of Portland cement paste, a mixture of cement and water of proper consistency, to the interior walls to help seal the surface. At least 2 weeks should be allowed for the curing of the completed structure before use. A 1- to 2-cord initial tempering fire is recommended to give the walls a slow pre-expansion and contraction exposure before applying any exterior coating of lime mortar or native clay pastes, and before wood pressures and operating temperatures are imposed on the kiln.

Steel ceiling. --The steel ceiling portion of all experimental kilns was similar in design. Such a design is recommended as follows:

Each ceiling consists of sectional, tri-rib type of steel decking or 18-gage, corrugated sheet-metal roofing placed crosswise of the kiln. The decking is supported by the inner edge of the walls, an angle-iron doorway lintel, and three to five lengths of 2-inch, black iron pipe running from front to back. With pipes spaced on about 18-inch centers, the number required will depend upon the width of the kiln.

Each pipe is supported by 3/8-inch hanger rods suspended from crosswise beams above the ceiling and outside of the coaling area. The supporting beams may be either new or used steel rails, angles or I-beams resting on the outer edge of the side walls, or independent pilasters. The supporting members could be woodlot timbers or bottom members of wooden roof trusses resting on the side walls, or bolted to poles or posts erected adjacent to the side walls of the kiln. The steel ceiling is covered with a 3-inch layer of sand to seal all joints against excessive air movement. Glass fiber should be packed around all hanger rods and into holes cut into ceiling steel to prevent loss of sand and movement of air into the kilns.

The steel ceiling sheets are usually installed from front to back in such a manner that the overlapping sides of one of the sheets near the back of the kiln is on top and the whole sheet is entirely free except for the weight of the sand covering. This is done to provide an area of relief against a sudden pressure of gas within the kiln. Each ceiling is also provided with four lightly covered smaller openings, two near the front and two near the back of the kiln. Each opening is about 5 by 15 inches in size. The forward openings serve as initial draft and smoke vents during ignition, while those located at the rear provide more positive heat circulation for the start of the coaling cycle. A cover is provided for each vent, so that each may be closed and sealed with sand during both the latter part of the coaling cycle and the cooling cycle.

All such metal ceilings have been satisfactory. Some excessive pipe sagging between hanger supports has occurred and at times permitted the ceiling steel next to the side walls to sag sufficiently to break the sand seal where the

ceiling rested on the side walls. Such a condition has been remedied by putting glass fiber packing between the top of the wall and the end of the steel sheets and by adding more sand. While considerable deflection of ceiling pipe supports can be tolerated, it will cut down on the maximum kiln capacity.. Preferably, the spacing of beams supporting the piping should not exceed 4 feet.

**Doors.** - -The doorway opening may be closed either by laying up dry standard-size masonry block and then plastering the outside joints tight with lime mortar or by using steel doors. Considerable labor is saved by using a steel door. Doors may consist of a single thickness of galvanized, corrugated sheet metal or two sheets of hot-rolled steel with or without insulation between them.

Single-faced doors have proven superior to the double-faced doors in several ways: (1) They can be bolted rather than welded together; (2) they do not warp as badly as the double-faced doors, which are deformed from the warping associated with the extensive welding of the rolled steel sheets together and to the framing angles necessary to obtain a tight seal; (3) any beneficial effect from the insulation added between the faces of the double-face doors is soon lost, in part because of settlement of the insulation; and (4) single-faced doors are much lighter, require far less welding, and are more easily handled, especially when suspended from an overhead trolley track by means of flexible steel chains. The door could consist of two sections operable from opposite sides of the doorway, as shown in figure 19. Such doors may be held together with "C" clamps, but must also be held a fixed distance apart to provide a space to hold the lime-paste sealant.

A few double-acting steel doors, hinged at the sides and meeting at the center, have been tried. They proved too hard to fit and erect, however, so are not recommended. Some steel doors can become too badly warped to permit use of lime paste as a sealant. In that case, a strip of glass fiber insulation can be pasted along the edge of the door with a tar-type adhesive. This will form an effective gasket to receive and hold the lime-paste sealant in place.

A number of commercial kilns are employing the suspended type of single-faced door constructed of a relatively light-gage galvanized, corrugated sheet metal. Overlapping side edges are bolted together in the horizontal position, and the light-gage metal is bolted to lightweight vertical framing angles. Doors are suspended by chains from an overhead I-beam or steel channel track, as shown in figure 25. Two or three "C" clamps are used along the top to clamp the door to a steel angle doorway lintel. Some are further held in place with pipe props at the sides or just by using banked earth along the bottom.

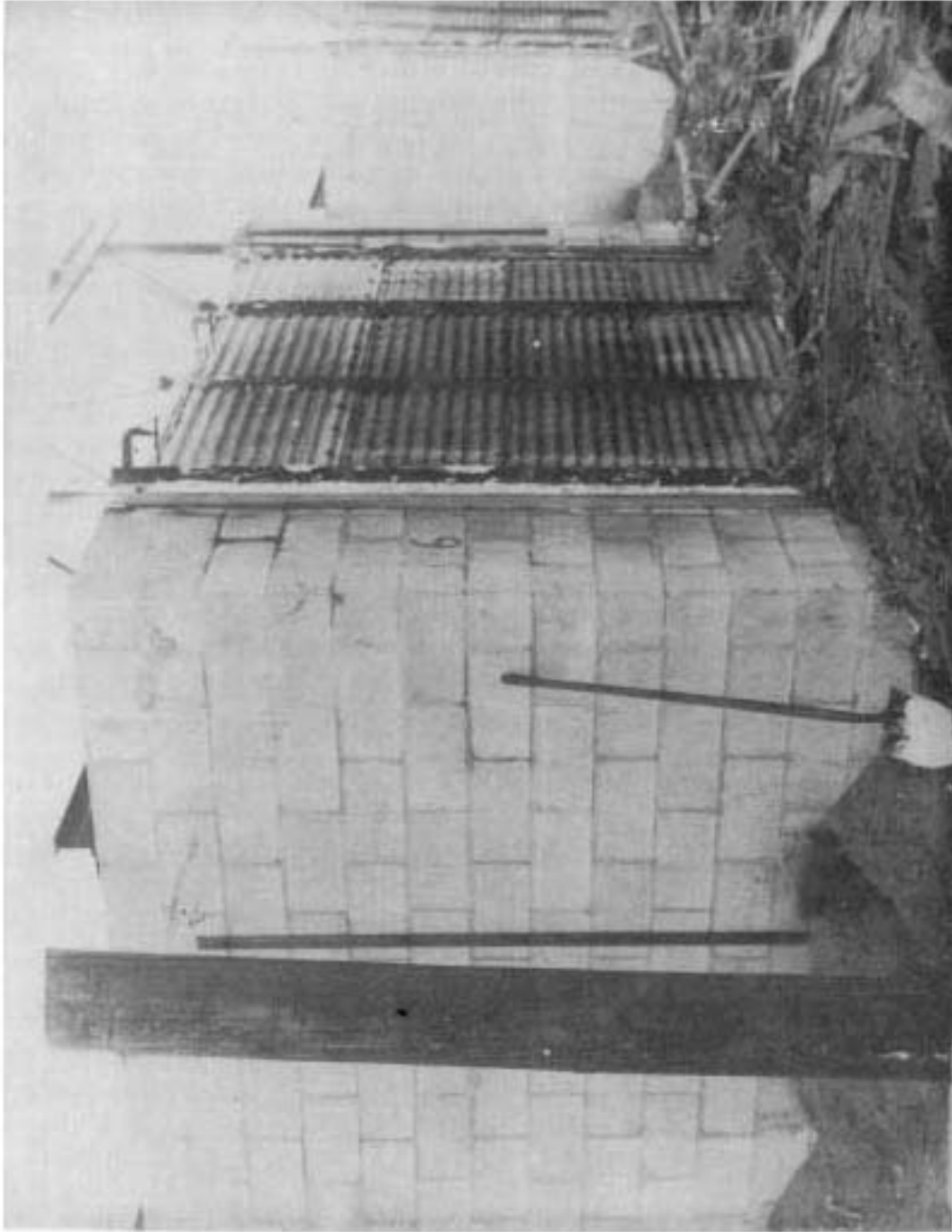

**Figure 25. --Corrugated sheet steel door suspended from channel-iron track.**

**ZM 100 992**

**Chimneys.** - - Either one or as many as four chimneys have been used on our experimental kilns. When only one chimney was used, it was located in the center of the rear wall. When three chimneys were used, another was added at the center of the length of each side wall. When four were used, one was placed at or near each of the corners of the kiln.

Six- or 8-inch-diameter sheet-metal chimneys are supported on loose steel plates resting on masonry block. Ceramic-type tees and elbows were used as the base of some of the first kiln chimneys. They proved too easily damaged and broken, so they were replaced with ordinary square chimney tile extending through the wall and into a single masonry block chamber or chimney base.

Chimney bases were constructed from loose pier-type masonry blocks placed directly on the ground, with loose steel plate covers resting on the blocks. Two 3/8- by 16 by 20-inch plates were used at each chimney. One plate next to the kiln was left loose and removable, so that a shovelful of sand could be added for closing off the chimney during the cooling period. The outside plate supported the chimney. It was provided with a 6- or 8-inch-diameter hole for the smoke outlet and with a chimney collar to receive and hold the bottom end of the chimney in place. Chimney bases normally were kept covered with earth during the coaling cycle to seal off the loose joints. Dampers were built into some of the earlier kiln chimneys about 5 feet above ground, but were found unnecessary.

Partial or full-length insulation of metal-type chimneys is helpful in the colder climates to retard the condensation and buildup of tars. Chimney tile has been successfully used inside masonry block chimneys in commercial-type kilns, particularly those partially or wholly buried in an earth fill. Some commercial chimneys have been made from concrete masonry block without any lining. All chimneys should extend at least 1 foot above the top of the kiln structure.

**Front air entry and side-wall air ports.** -- Entry of air through front and side walls has been tried. Front-entry air supply has given satisfactory results in both one- and three-chimney designs.

Front air entry is most easily obtained by hanging the sliding metal door so that there are about 3 inches of clearance at the floor line, It is then a simple matter to seal the opening a little at a time with earth or sand as less air is required. Some operators prefer to use blocks laid on their sides in front of the door to baffle heavy winds during coaling. When a laid-up masonry door is used, blocks of the first course are laid on their sides so that cores are horizontal. Then earth or sand is used to close off the openings as less air is needed.



**Sidewall air ports are made by omitting half blocks in the base course at pre-determined locations along the side walls. Each opening can be lined with chimney tile or brick if desired, or used without lining if cinder-concrete is used. Air ports lined with chimney tile can also be used as chimney openings.**

**Roof structure . - - Although a roof structure is not a part of the kiln, it is desirable for shedding rain or snow and to protect ceiling parts from early corrosion. When roof trusses are used to support the steel ceiling, the roof structure becomes essential. The kiln may be roofed in any convenient way, with either boards or sheet-metal roofing. Trusses can be assembled from ordinary woodlot lumber. A simple shed-type roof framed with poles or material slabbed on two sides or squared for rafters and beams would also furnish the necessary ceiling protection.**

**Some roof structures are supported on poles or pilasters that are independent of the kiln walls. Others are supported on wood posts or brick or masonry-block piers built up on the outer wall of double-wall kilns, or at the outside edge of single-wall kilns. Such points of load concentration on the masonry walls are believed to restrain the wall from normal movement and thus accentuate a tendency of vertical cracks to localize near such bearing points, especially in single-wall structures.**

### **Recommended Structural Practices**

**A number of favorable and unfavorable construction methods that were used during this experimental work have been discussed. A summary of the more favorable methods and some things to avoid doing when constructing a masonry kiln follows:**

- (1) Use perimeter-type reinforced concrete footings for support of kiln walls. Keep wall footings separate from any floor slab construction.**
- (2) Use dense, moist-cured cinder-concrete masonry blocks if at all possible. Cinder-concrete has proven the most satisfactory of all lightweight aggregate blocks, because its thermal expansion is generally less than that of all other masonry materials except firebrick. Protect inner walls in the vicinity of air inlets with firebrick or a castable refractory coating. Use of front air entry will eliminate need of any air inlet wall protection.**
- (3) Use three or more courses of lintel-type block with reinforcing bars and concrete in all single-wall structures. Bars should be lapped or bent so as to be continuous around any corners. Avoid use of inward-projecting door pilasters at the front end of side walls. Such wall stubs are vulnerable to**

damage from expansion of the doorway lintel and from trucks and mechanical equipment. Select kiln dimensions such that a full-width doorway opening can be used.

(4) Avoid use of structural steel shapes for unsupported members within the coaling chamber. All steel members, such as lintels and ceiling pipe, must be supported by face-standing columns or other means outside the kiln chamber. When ceiling support beams or roof trusses bear on the side walls, limit their anchorage to the use of punched metal strapping nailed to the surface of the blocks. Do not drive anchor bolts into the masonry. Avoid heavy load concentrations on side walls. Avoid concentrated points of restraint to the normal movement of the concrete masonry as far as possible.

(5) Use galvanized, corrugated sheet metal for ceilings and doors. Avoid overloading ceiling steel. Do not use more than the required 3 inches of sand cover.

Use a door stop at center of wide, one-piece doors to prevent the bottom edge of the door sill warping toward the inside of the kiln. A recess may be provided in the concrete sill to receive a removable steel-pin stop before the door is closed.

### Operation of Rectangular Kilns

Kiln operation can be carried out in a number of ways and oftentimes with as many different results. Information developed in the operation of experimental, rectangular field units provides some positive steps which may be included to give the more favorable results (75). This information includes also the relationship of several of the important operational factors, together with the results of methods developed and observed elsewhere. Much of this information will be of value in the operation of similar-type commercial kilns as well.

### Kiln Raw Material

Three types of wood are generally used: (1) cordwood, (2) sawmill slab and edging stock, and (3) blocks and short-length material from sawmills or wood-manufacturing plants. Cordwood and slabs and edgings are usually 4 feet or more in length, and short-length discarded material may vary from about 3 to 16 inches in length.

Wood for a given charge preferably should be of the same general form, size, and moisture content. This will simplify wood handling, and coaling of the charge will be more uniform. It is best to put any overly large pieces at the upper (hotter) part of the charge. Roundwood more than about 8 inches in cross section should be split or cut to shorter lengths.

### Kiln Charging

The manner in which a kiln is charged depends primarily on the type of wood and the location of openings for regulated air entry and smoke outlets. The main object is to stack the wood so that the combustion gases can circulate freely through the pile and most effective use made of kiln capacity.

Cordwood and slabs are usually hauled to the kiln by truck or tractor, and the pieces are stacked in the kiln by hand. The sticks are commonly piled horizontally, parallel to the sidewalls and on stringers, as shown in figure 26.

The use of stringers leaves less space for the charge, but better circulation of air and hot gases is thus gained with the result that there is less partly charred material. This material, called "brands," accumulates usually near the floor of the kiln, where temperatures are lowest. Stringers need not be classified, since they may include roundwood up to about 6 inches in diameter or brands laid end to end, rough poles, or in some cases structural steel shapes. The stringers should be placed so that they obstruct air intakes and chimney outlets as little as possible.

Small pieces are dumped into the kiln from a truck or conveyor, or thrown in by hand. If stringers are used, they can be covered with a layer of cordwood or slabs to support the small pieces.

Wood of any form should be placed close to the kiln walls and ceiling but not so tightly packed that it prevents free circulation of the heating gases. Sawdust, shavings and similar wood fines in masses conduct heat slowly, and the coaling of such materials in kilns is therefore difficult and highly inefficient.

### Temperature Measurement and Instrumentation

Measurement of temperatures is highly important in kiln operation, since the coaling process is controlled by means of temperature and time. The temperature at any given time during the coaling cycle, therefore, gives a direct and reliable measure of the progress of the run. Except possibly at the end of the coaling period, smoke color and volume indicate little regarding the actual

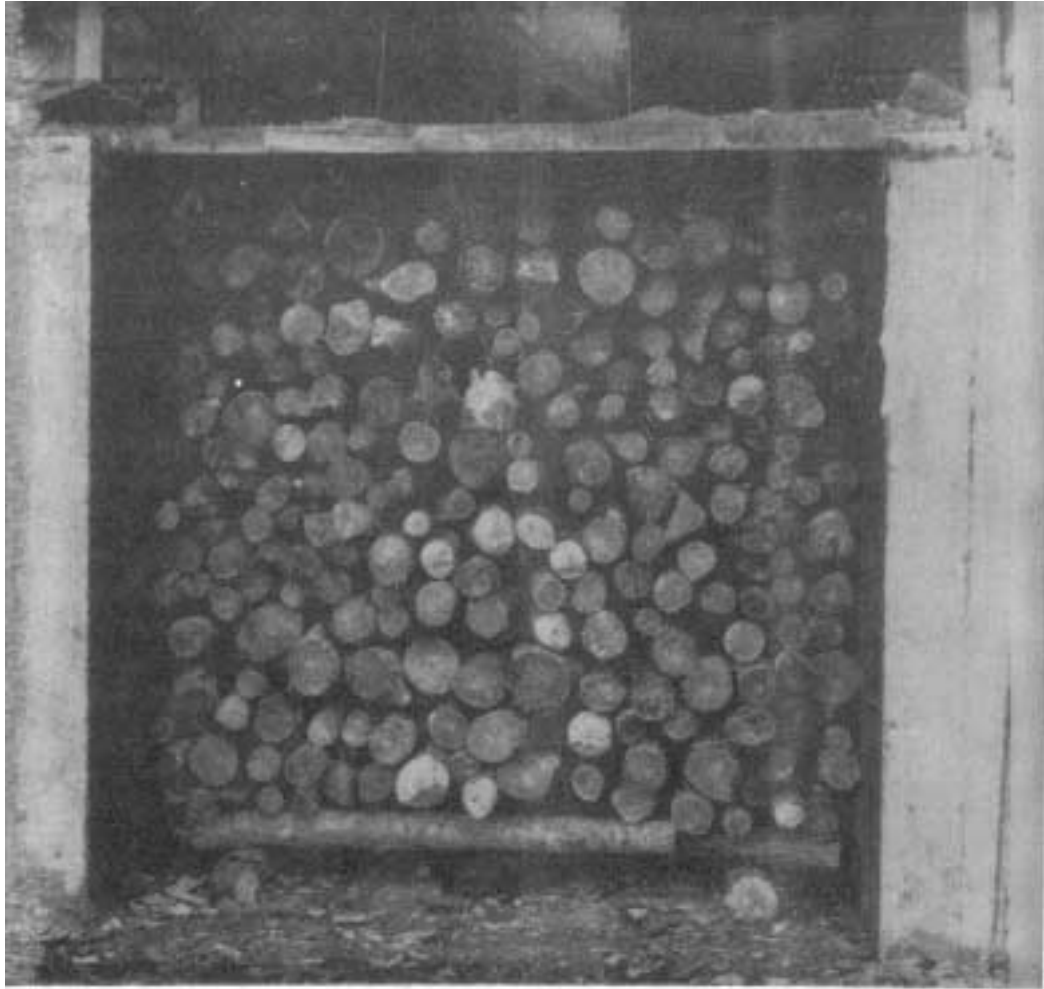

**Figure 26.- - Sticks piled for kiln charge.**

**ZM 117 156**

pattern or progress of coaling. By controlling operating temperatures at about 850° to 950° F., coaling can be conducted with highly favorable results (62). Figures 27 and 28 show an inexpensive direct current microammeter and suitable location of thermocouples within the kiln. The assembly and use of the meter are described in the appendix.

### Charge Ignition

The heat for initial drying of the charge is provided during the ignition period. This heat is supplied by burning wood fuel placed at midpoint or in front of the charge, or by an oil- or gas-fired torch at similar locations.

Some ignition fuels commonly used are dry kindling wood, brands, charcoal, and fuel oil. The amount of fuel required depends chiefly upon the moisture content of the wood to be coaled. Figures 29 and 30 illustrate the different amounts of wood fuel used for the ignition of unseasoned and seasoned charges.

Torch method.--One of the most efficient methods for igniting a charge is with a kerosene- or gas-fired torch (45) as shown in figure 31.

These torches are comparatively inexpensive and provide a high-temperature heat source capable of igniting separate parts of the charge in a very short time. The torch flame is directed through one or more air ports until the charge is burning. Normally, this takes about 5 to 10 minutes. Additional fuel is not usually required, although, with unseasoned wood, a small amount of charcoal in the ignition area will provide proper heating conditions more rapidly.

Ignition with a torch has a number of advantages compared to other types of fuel placed directly in the kiln. The time needed to prepare and place other fuels is eliminated. Ignition of the charge is practically assured, whereas solid fuels furnish variable amounts of heat from which ignition may at times develop slowly or possibly not at all. Additional space is made available for charge material also when the torch ignition method is used.

Open-door method. --Ignition with the kiln doors temporarily open has been successfully employed in a 7-cord, experimental unit. Dry fuel is placed at the front of the charge, wetted with fuel oil, and ignited with the doors fully open (fig. 32). Auxiliary ports in the kiln ceiling and slightly to the rear of the ignition area are open also. After a 5- to 15-minute period of vigorous combustion, the doors are closed. The front ceiling ports are sealed about 1/2 hour after the doors are closed, and the rear ports are gradually closed after an average ceiling temperature of 950° F. is reached.

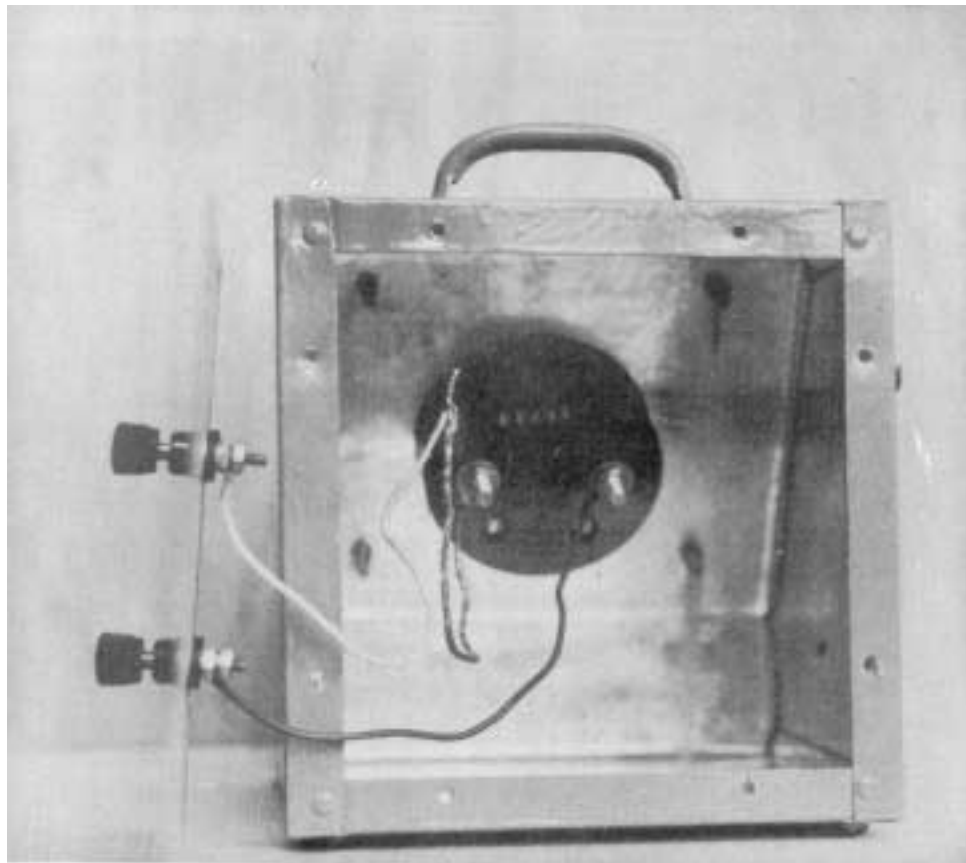

**Figure 27. -- Microammeter calibrated for measurement of kiln temperatures in degrees Fahrenheit.**

**ZM 118 302**

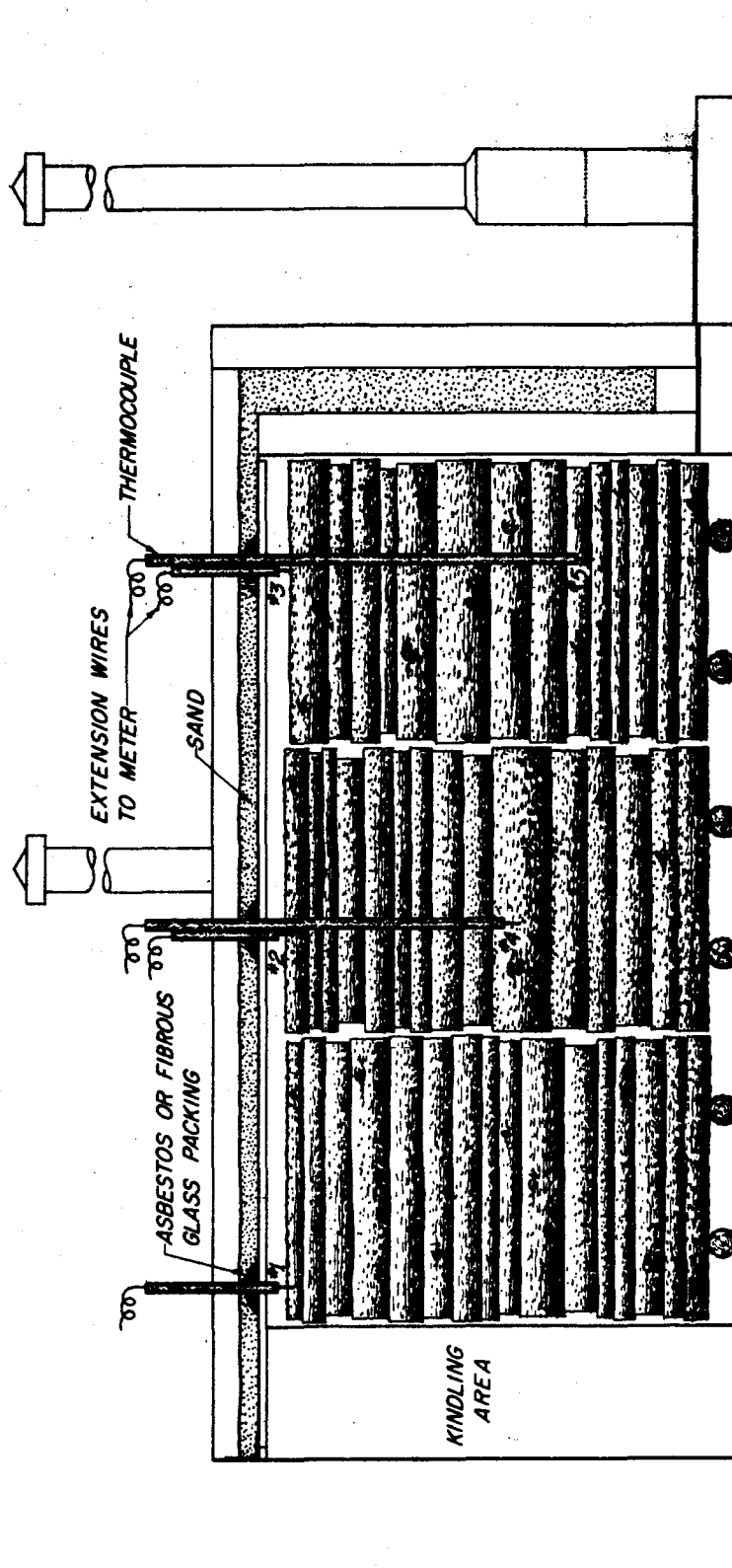
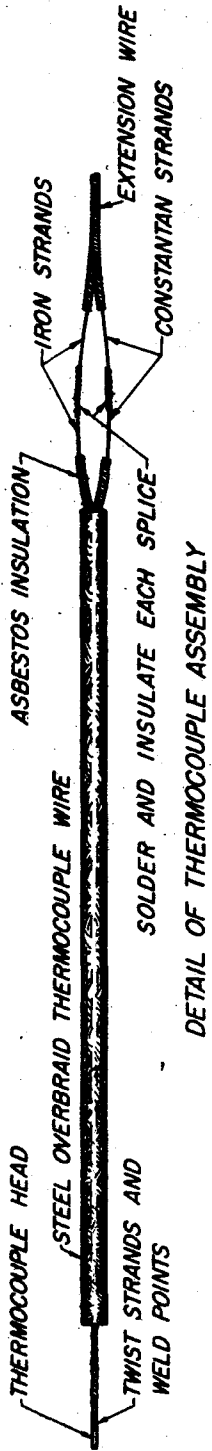
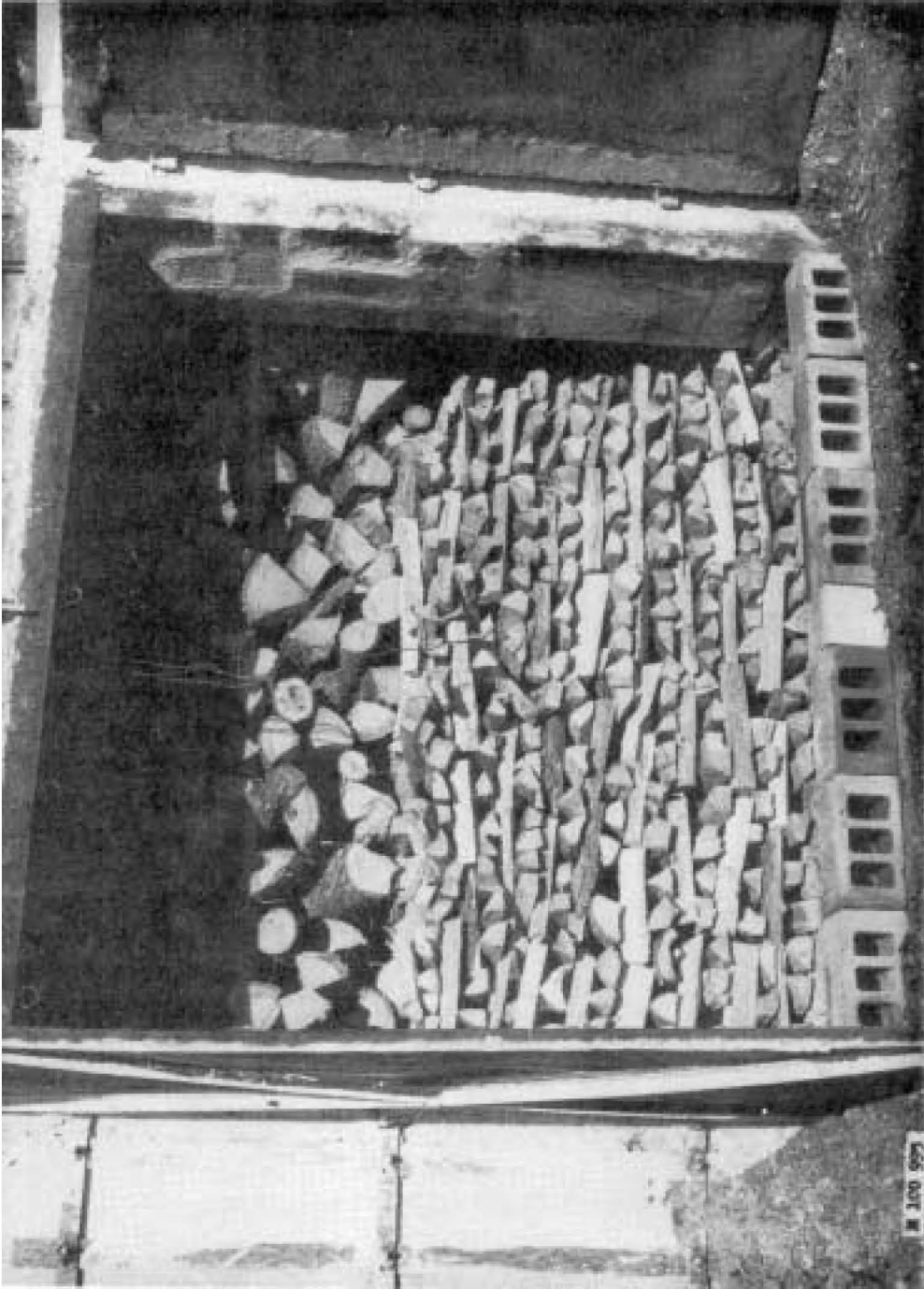

Figure 28. - Detail of thermocouple assembly and location of thermocouples on the lengthwise centerline of kiln, indicating approximate distance from kiln floor.

ZM 111 344



**Figure 29. - - Fuel stacked for ignition of kiln charge of green wood.**

**ZM 100 995**



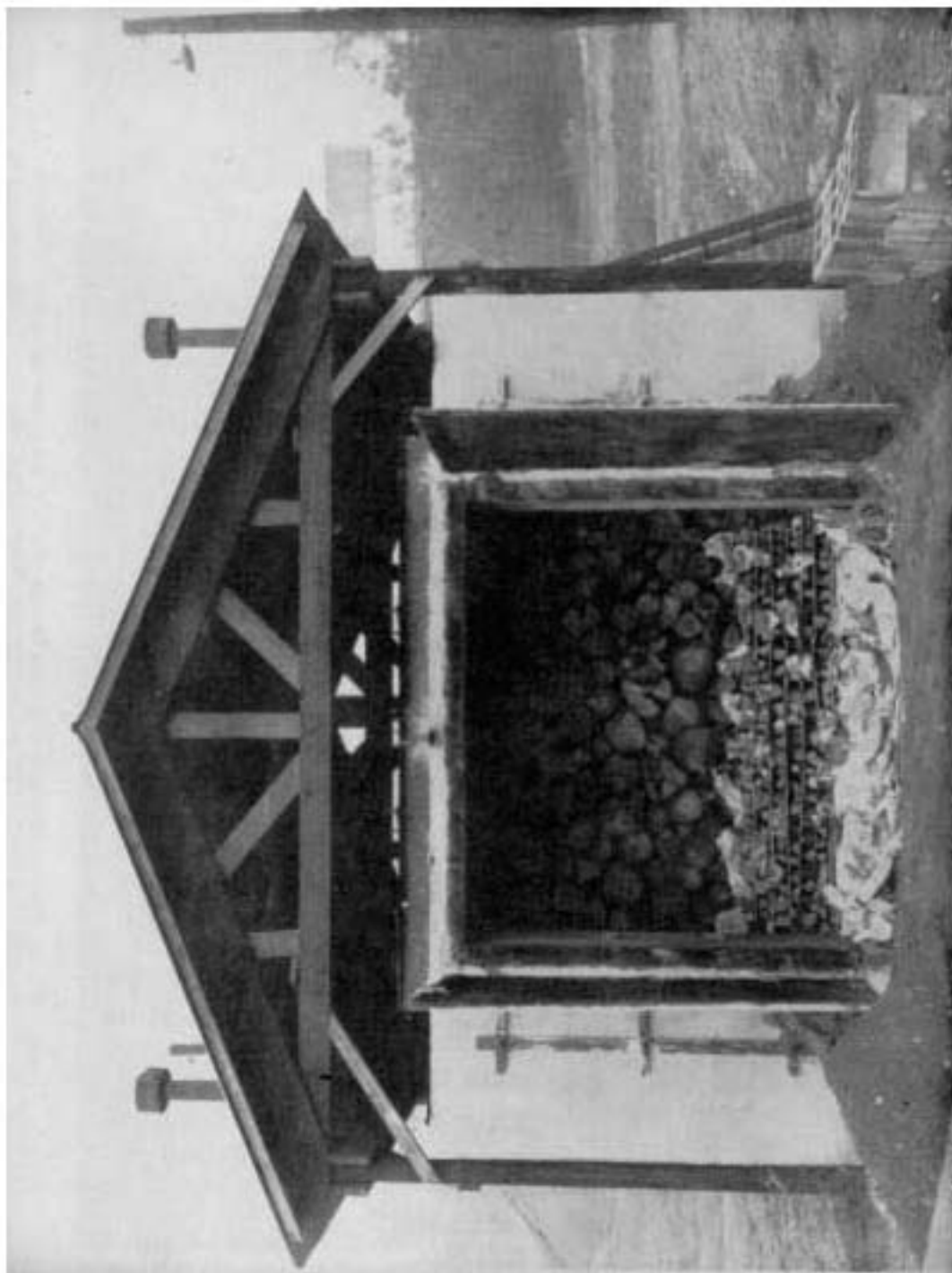

**Figure 30. --Fuel stacked for ignition of a kiln in charge of seasoned wood.**

**ZM 100 994**



**Figure 31. - - Igniting the kiln charge with a torch.**

**ZM 117 157**

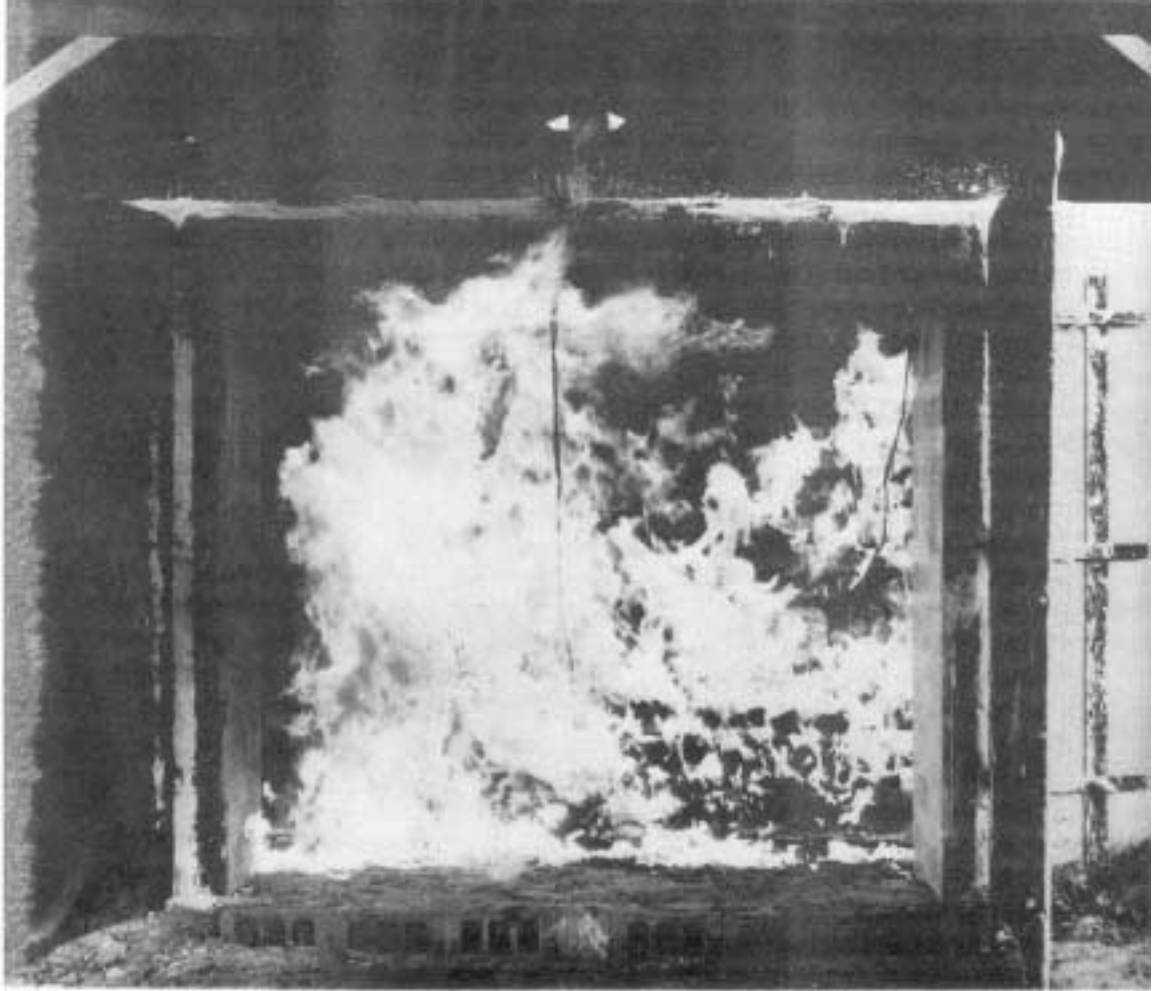

**Figure 32. - Igniting a kiln charge by the open-door method. All block openings are utilized for air entry during the early cooling stage.**

**ZM 109 800**

The chief advantage of this method is the presence of plenty of air for quickly establishing the required temperature throughout the coaling zone over the front of the charge. This method of ignition is suitable only for kilns with adequate vents and doors that can be quickly and safely closed when the fuel is burning rapidly.

While the doors are open, quite high temperatures are indicated initially by the ceiling thermocouple over the ignition area. At the same time, the average, ceiling temperature determined by other spot readings is much lower. When the door is closed, the average ceiling temperature drops rapidly to between 400° and 500° F. The temperature then gradually rises to the desired coaling level. Periodic temperature observations should be made and readings recorded on a systematic time basis to note the progress of the run. Such information proves useful for the control of later runs.

Closed-door method. --It takes about the same amount of fuel wood and oil to ignite a charge by the closed-door as by the open-door method. With the door closed, a means for firing the fuel must be provided. Since the space for air entry under the door is left wide open, the fuel is ignited by inserting a burning taper under the door to the oil-soaked fuel. When ignition is well under way, masonry blocks are laid side down along the base of the door, so that the hollow cores serve as air-intake ports. The air intake is then regulated for controlled coaling by gradually closing the openings in the masonry blocks. In kilns having a number of side ports for air entry, the ignition fuel is generally fired through forward ports at opposite sides, and sometimes through forward ceiling ports as well.

The procedure for closing the ceiling ports is the same for both methods. The rise in temperature after ignition, however, is not so rapid generally as in the open-door method. Using similar ignition methods, unseasoned wood is more difficult to ignite than seasoned wood. More initial heat is required for the wetter material, and the only means for gaining ignition effectively is with an abundance of ignition fuel and draft conditions favorable for good combustion. Anything less than an active, full-face ignition will not give enough heat to dry the upper portion of the charge for the start of a suitable coaling zone. With improper ignition, only a small fire is likely to result, and it may continue to burn for a long time before a desirable coaling temperature is reached. Such operation results in lost production time.

With the use of seasoned wood, satisfactory ignition is more easily obtained. When using the closed-door method in kilns having side-port air entry, one stack, and no ceiling ports, it is sometimes necessary to promote draft by placing a fire at the base of the stack. When coaling starts, there is usually sufficient heat to maintain positive stack draft.

The use of front and rear ceiling ports in a kiln will permit escape of the initial smoke and also aid in the development of proper kiln temperatures. The front ceiling ports can be gradually closed when ignition is well under way. As the coaling temperatures increase, the rear ceiling ports are gradually closed when ceiling temperatures approach 950° F.

**Ignition control.** -During ignition, a large amount of air is necessary for the rapid combustion of the starting fuels to insure the heat level needed for coaling. This air is supplied through groundline ports in the kiln side walls or through temporary openings under the kiln door. A fan has also been used to provide air for ignition and promote chimney draft.

The auxiliary ceiling ports in some kilns serve as temporary chimneys and aid ignition by causing greater amounts of air to be drawn into the kiln through the air ports and aiding removal of smoke from the kiln.

The ignition pattern is generally similar for all types of kilns. During the first 5 to 15 minutes, temperatures in the ignition area will rise rapidly to about 1,000° F. After much of the fuel has been burned, the temperatures will quickly drop, often to as low as 300° F. The extent of the temperature drop is closely related to conditions of air supply and to the moisture content of the charge. With the establishment of a suitable ignition zone, however, the temperature gradually increases to about 540° F. The ignition period is considered complete when this temperature has been reached.

Since kiln temperatures are controlled by regulating the air supply, the amount of air entering the kiln following ignition must be limited to that needed for slow or incomplete combustion. If the burning becomes excessive, the temperature will rise rapidly to above 1,000° F. and a part of the charge may be consumed instead of forming charcoal. If left unchecked, part of the charcoal already formed may likewise be lost. In extreme cases, the entire charge may be reduced to ashes and the kiln seriously damaged or destroyed.

**Coaling-cycle.** --Satisfactory carbonization depends primarily on maintenance of proper burning conditions in the coaling zone. Sufficient heat must be generated first to dry the wood and then to maintain the temperatures necessary for efficient carbonization. At the same time, the burning must be limited so that only sufficient heat is present to produce good charcoal. Kiln temperature is thus the most reliable measure of control.

For the production of good-quality charcoal, kiln temperatures from about 850° to 950° F. are required. This charcoal will have a fixed carbon content of about 75 to 82 percent. Prolonged higher temperatures will reduce the yield of charcoal without necessarily upgrading it for recreational use. If, on the other hand, coaling temperatures remain quite low, the charcoal may

be too "smoky" for major domestic use, and larger than normal amounts of brands will be produced.

During the coaling cycle, a careful check of kiln temperatures should be made and the air ports adjusted as necessary. The temperatures should be checked at least every 2 to 3 hours for satisfactory control. More frequent checks are advisable when seasoned wood is coaled or during periods of strong or variable winds.

The air supply is regulated by varying the size of the air-port openings. Undesirably fast combustion caused by strong winds can be modified or controlled by use of baffles in front of the air openings. The location of openings for air to be admitted during coaling depends largely on the kiln design and the coaling pattern desired.

The direction and rate of spread of the coaling zone is associated with a number of factors, such as location of air ports and chimneys, volume and velocity of the incoming air, wood size and moisture content, piling of the charge, and design of the kiln.

Coaling generally proceeds at a faster rate at the upper part of the charge, where higher temperatures are available for longer periods of time. Less rapid coaling takes place near the kiln floor, where the average temperature usually is lowest.

In rectangular kilns with a single chimney at the rear, the coaling zone progresses from the front ignition area to the rear (35). The air-intake ports are located along the side walls at the base of the kiln. These ports are regulated in pairs one of which is located opposite the other. Following ignition, the first pair of air ports is open and the others sealed. As the run progresses, the coaling zone arches from the front and across the top of the charge with gradual inward and downward movement. When glowing is observed at the first pair of air ports, this pair is sealed and the next pair opened. This stepwise procedure is followed until all air ports have been opened and resealed, at which time coaling is generally completed.

Variations of this method for establishing the coaling zone have been used. One was included in another study (37). in which the center of the charge was ignited and the coaling zone spread in opposite directions.

In other methods (16,90), the supply of air may be continuous from one general location, as under the door, or through one or two pairs of ports near the front of the kiln. With a single opening for air entry, more than one chimney may be used to provide better air distribution and more rapid movement of the coaling zone.

**The coaling pattern is not always uniform or predictable when there are strong winds. One result is the formation of "hot spots" or areas of more active burning, which may raise the temperature above 1,000° F. Most are of short duration (less than an hour) and not serious. Where pockets occur in the load, however, as between two tiers of wood, spot burning may become severe because air is channeled through such pockets.**

**Smoke may puff outward occasionally through the air-intake openings. Such a change from normal circulation may be due to chimney downdraft or possibly to too rapid buildup and trapping of gases near areas of excessive temperature. Occasional light puffing from the air ports is of no serious concern. Should puffing be frequent and vigorous, irregular coaling conditions are indicated and corrective action must be taken. Temporary reduction or stopping of the air supply will generally provide a suitable remedy.**

**The time needed to complete the coaling cycle depends primarily on wood moisture content, kiln size, and temperatures during coaling.**

**It is essential that the water in the wood be removed before a zone of coaling action is formed. Therefore, wood with high moisture content will require a longer period for drying than already seasoned material. It is possible to reduce the coaling time by as much as 40 percent with seasoned material (82).**

**In general, coaling time is related to kiln size. When the wood and operating conditions are similar, the time required for coaling in a 10-cord kiln will be approximately twice that in one of 5-cord capacity. Means for modifying the rather fixed rate of temperature rise to coaling conditions in kiln charges are limited. Attempts to speed up the rate--as, for example, by allowing more air to enter--will raise kiln temperatures excessively and impair charcoal yields and properties.**

**It is possible, however, to adjust coaling time by changing the size of the coaling zone and the manner in which it is directed through the charge. In rectangular kilns, it has been possible to reduce the coaling time greatly by center firing. In the application of this method, the coaling zone widens in opposite directions simultaneously, as compared to one-direction movement obtained with end firing. Some results from the use of both methods are given in table 1.**

**Table 1.- Comparison of coaling time for sugar maple roundwood with two methods of firing. Data are from 6 comparable runs in 3-cord experimental kiln**

Coaling method	No. of runs	Average	Charcoal			Average
		of wood moisture content	Average yield, oven-dry, by weight	Percent	Percent	coaling time
		<u>Percent</u>	<u>Percent</u>	<u>Percent</u>	<u>Hours</u>	
End firing (1 zone)	3	29	29	79	21	
Center firing (2 zones)	3	35	29	79	12-1/2	

Further experimental results obtained by the use of center firing with multiple chimneys from 3-cord sheet-metal and masonry block kilns (45) are shown in table 2. The data are from 11 runs made in the same manner, using methods of torch ignition and fan-controlled draft referred to previously. The raw material was 4-foot roundwood 3 to 10 inches in diameter. Six runs were made with seasoned wood and five with freshly cut or unseasoned material.

It is likewise true in the operation of rectangular kilns that much less coaling time is needed with the use of single air entry and multiple chimneys than with multiple air ports and a single chimney.

The end of the coaling cycle is readily shown when a temperature within a range of 750° to 850° F. has been reached at the low thermocouples placed farthest from the ignition zone. Completion may also be indicated when smoke volume is reduced to little or nothing.

Cooling cycle. - - When coaling has been completed, all air ports are sealed for the start of the cooling cycle. After the ports are sealed, the chimneys should remain open until smoking has practically stopped. This permits the escape of any smoke that may be formed during cooling and prevents the development of gas pressure in the kiln. Chimneys can usually be sealed from 1 to 2 hours after the air ports are closed. They should be sealed immediately after they stop smoking, because fresh air may be drawn in by normal cooling, or a downdraft in an idle chimney may admit enough air, to support combustion or possibly cause an explosion.





A very small crack or opening in the structure through which air may enter can prolong combustion in the form of a hot spot and cause undue lengthening of the cooling period. Such hot spots may flare up when the kiln is opened. It is important, therefore, that all possible air-entry openings be sealed during the cooling cycle. This means frequent checking for cracks in the walls, doors, air ports, chimneys, and ceiling. Air ports at groundline and at the base of the kiln door are usually banked or closed with sand. Cracks are sealed with lime slurry or mortar cement. Roofing tar is often used for sealing cracks. Because it expands and contracts with wall movement and is quite stable, it may last for several runs. Cracks repaired with a lime slurry usually require resealing after each run. Roofing tar should not, however, be used to seal openings around doors or be placed in contact with other hot metal.

When temperatures have been reduced to 150° F. or less, it is generally safe practice to open the kiln. Before the kiln is opened for discharge, however, the charcoal should be checked for localized hot areas that were not evident during the overall kiln temperature measurements. This check should be made by opening several air ports and one or more chimneys. If the temperature does not rise within 2 hours, it is considered safe to open the kiln completely. If the temperature rises, however, the kiln should be resealed and carefully checked for sources of air leakage.

The time required for cooling depends largely on the rate of heat loss by radiation through the kiln walls, door, and ceiling. Double-wall structures or those enclosed with banked earth will cool at a somewhat slower rate than single-wall structures with exposed outer surfaces.

Exploratory studies have been made with water to hasten cooling (35,70,83). Results indicate that cooling time can be reduced as much as 60 percent by spraying water over the top of the charcoal bed. The amount of water needed has been estimated to be from 100 to about 350 gallons per ton of charcoal. Care should be taken that the cooled charcoal will contain no more moisture than is generally allowable in a marketable product.

Kiln discharge. - - Charcoal is a bulky, dusty material that is difficult and costly to handle manually from the kiln. Mechanized yard handling and transport operations, therefore, have distinct advantages. The kiln can be discharged and charcoal moved about more efficiently and conveniently, for example, with a tractor scoop (fig. 33), or belt conveyors and bucket elevators.



**Figure 33. -- Tractor with scoop being used to discharge kiln.**

**ZM 118 483**

## Safety Precautions in Kiln Operations

### General

In the production of kiln charcoal, accidents can be greatly reduced by making use of safety features and safe work habits. Careful planning of work, and good housekeeping also promote safety. In this business as in any, where fire and high-temperature operating conditions are commonplace and extensive, carelessness or slovenliness can be ruinous.

While kiln operation is simple, much depends upon the judgment of the operator to keep production safe. Production hazards increase, and undesirable or dangerous burning conditions can arise if the operator neglects to pay close attention to such vital operational factors as the weather, structural condition of the kiln, coaling time, and temperatures. There are ample records of kiln damage and destruction because of just such neglect and oversight.

### Types of Hazardous Conditions

Explosions. --Kiln explosions can have extremely serious results. The causes of such accidents are not clearly understood. They are most often caused, perhaps, by mixtures of hydrogen or methane and air. Since varying amounts of these gases are no doubt present during most of the coaling action, the formation of explosive gas mixtures can be perhaps minimized by efficient use of the air admitted. The admission of more air than is needed for uniform and progressive coaling action might well result in formation of explosive gas mixtures.

In some experimental runs a "puffing" or pressure-release action of kiln gases has occurred at times when the charge was coaling in a controlled and orderly manner) the coaling zone was uniform and well-established, and air input was closely regulated for proper coaling temperatures. This puffing, which has been observed to occur more often with seasoned than with unseasoned wood, may cause sheet-metal doors to vibrate at times. While the puffing is of itself not severe, the causes of it could, if disregarded, create explosive conditions. An explosion would very likely result in wall cracking and admission of more air. This could in turn lead to more severe structural damage as the additional air stimulates even higher temperatures.

There is some reason to think that periods of uneven gas distribution may provide conditions for the accumulation of uncombusted gas. Under such conditions, puffing could take place repeatedly as more air is admitted and gas accumulates again.

Another possible explanation for kiln explosions has been given by a Swedish source (23). The period of greatest danger, according to this source, is during the early coaling stage, when comparatively large volumes of water and other vapors are being condensed on relatively cool wood. The noncondensable gases, including those capable of explosion, are thus free to form critical mixtures with air.

The fact that kiln explosions occur only infrequently would suggest that average operating conditions are for the most part satisfactory. The comparatively few explosions that do occur are probably due to coaling conditions in which air is uncontrolled.

Structural fires. --Kiln explosions are a major cause of structural fires. While the explosion itself may cause only minor damage to the kiln, fire can result from the admission of large quantities of air to the kiln through cracks. Prompt sealing of any structural breaks caused by the explosion is therefore essential to prevent outbreak of fire.

Other causes of fire are the operator's unfamiliarity with proper operating steps and outright carelessness. After making several successful runs, the operator cannot relax his vigilance and assume that, during the coaling period, the kilns can be left unattended. No two runs can be made exactly alike as changes in weather, in the kinds and condition of the raw material used, and other factors make each run different.

With prolonged heating, there is always danger of wall cracking or separation. Should either occur and remain unnoticed, the seepage of excessive amounts of air through such openings could easily make a change in the coaling pattern. These changes might lead gradually to very high temperatures) or they might take place rapidly, creating a serious fire condition. The operator's familiarity with his equipment and the steps necessary for good operation are the best insurance for safe practice and satisfactory production. Well-established, periodic inspection will indicate oftentimes the corrective measures necessary for proper control and reduce the possibilities of damaging fir es.

Commercial kilns have been damaged or destroyed because of unexpected developments during the coaling cycle. Of major importance also are the reduced yields and loss of operating time due to improper sealing of the kiln during the cooling period, together with the possibility of heat damage to the structure from burning charcoal. Such conditions may happen even though a well-standardized pattern of operation has been established. The importance of inspecting and maintaining kilns during the coaling and cooling cycles, controlling operational conditions, and using safe practices cannot be over-emphasized.

Temperature-indicating equipment suitable for operational control (61,62), during coaling and cooling periods, together with an outline of safety-procedures, is described elsewhere in this report.

**Hazards to workmen and public.** - Fire, whether controlled inside the kiln or uncontrolled, constitutes a potential hazard to workmen and the public alike. Unauthorized persons, including the public, should not be permitted in a hazardous area unless guided. Transport of wood, charcoal handling, and other essential work involves hazards to safety. In charcoal production, as in any kind of business, workmen must be well informed of operational hazards. Safety measures and safe work habits must be considered of prime importance.

### **Safety Equipment**

**Temperature indication and control.** --Equipment that indicates kiln-operating temperatures, essential for gaging the progress of the coaling and cooling cycles, is also an invaluable aid in controlling fire hazards. As temperatures fall or rise, more or less air should be admitted, thus maintaining desired control of burning. Inexpensive thermocouple-type instrumentation for one or several kilns is available and should be installed.

**Air-port closure plate.** - Some development work has been done with a safety plate for use in multiple-stack, masonry-block kilns with metal doors and under-door air entry. While not entirely reliable, it provides an added margin of safety.

This device, designed to overcome or control puffing with resultant vibration of the door during the coaling cycle, has been improvised as a safety measure. It consists of a weighted half-section of a heavy metal hinge propped horizontally above the air-intake port. The half-section is lightly supported on a thin metal prop, and a trip rod is placed between the kiln door and the metal prop. When the door vibrates in response to strong puffing action, the trip rod 'pushes the hinge prop sufficiently to drop it over the air port. Air is thus automatically cut off from the kiln, thereby removing a cause of puffing and possible explosion and fire.

**Stack closure plate.** - A chimney-port safety closure has been developed for multiple-stack kilns to prevent air entry when any one chimney stops smoking during the coaling cycle. Working properly, the device forestalls entry of excess air into the kiln through the stacks and allows coaling to proceed without danger of accelerated combustion and heat buildup. The basic idea of this device has potential application also for single-stack units and for kilns of other than masonry block construction.

The heavy metal plate is held in place by a dry wood 2 by 4 over each of the inside chimney openings. It is installed before the kiln is charged. A metal guide rod placed on the chamber side prevents the plate from tilting inward as it drops. A 3/8-inch rod welded to the plate provides a stop for the diagonally placed stick, thus securing the closure plate in the closed position. The plate drops and seals the port only when the wood support has been partially burned as coaling combustion reaches this location. The wood prop will burn sufficiently within 30 minutes to cause release of the plate for temporary port closure, or until it is possible to make a permanent and airtight seal. Good closure is generally made when the plate is cut oversize to provide at least a 4-inch margin of metal from the top and sides of the chimney opening.

This improvised device is most useful when unusual combustion conditions associated with ashing occur rather than during normal carbonization of wood. The wood prop supporting the plate, even though it will burn under normal coaling conditions, usually remains sufficiently strong under these conditions to support the plate. Under normal coaling conditions, therefore, an active chimney would not be sealed.

**Stack antidown-draft caps.** - Air diverters of various kinds on chimney tops prevent sudden downdrafts into the kilns. Prevention of downdrafts is helpful in avoiding overactive coaling combustion and minimizing the danger of explosion. Satisfactory results can be obtained by the use of a simple, fixed-type hood fabricated of thin-gage sheet metal. One design for a suitable diverter consists essentially of an inverted dished section slightly larger in diameter than the chimney and secured about 6 inches above the chimney top in a horizontal position. A metal skirt, somewhat greater in width than the 6-inch space between the chimney top and the dished section, is secured by metal supports from the chimney and positioned outward several inches to surround and baffle the 6-inch space above the chimney top.

Unregulated and more than needed amounts of air may enter the air ports as the wind changes in force and direction, and harmful effects to the coaling cycle will develop. Baffling or temporary closure of the air ports facing strong winds is recommended.

### **Location of Kilns**

Because a fire hazard is always present during charcoal production, kilns should be located away from other buildings, and brush or other flammable material should be removed.

A site should be chosen that is away from populated areas to avoid creating a smoke nuisance. Under some atmospheric conditions, kiln smoke settles and drifts near the ground. A site on high ground, therefore, is preferable because prevailing winds will carry the smoke into upper air strata. Smoke can also be partly or entirely eliminated by combustion in a burner (53) where some other means of removing it is essential.

**Water supply.** - -A water supply is highly important to any kiln operation. When at all possible, water should be stored in a yard tank or piped to the kiln site. A hose with nozzle should be kept ready for immediate use. Back-pack water pumps or large-capacity fire extinguishers provide some measure of fire protection.

**Limited public access.** --The control of unwarranted traffic in and about a kiln area is desirable. The operating area should be fenced; or, as a minimum measure, warning signs against trespassing should be erected.

**First aid accessories.** --Adequate first aid supplies, including dust masks, should be kept conveniently at hand.

### **Safe Operating Practices**

The fact that charcoal production in kilns is a comparatively simple operation should not mislead operators into thinking that safety practices are unnecessary. A number of essential points dealing with operating safety are worthy of note.

The coaling of wood takes place in widely different patterns, depending a good deal upon moisture content. Fairly large amounts of heat are given off when wood changes to charcoal. This heat, together with that of charge combustion, is more gradually used in charges of unseasoned wood than in charges of partially or thoroughly dry wood. Kiln temperature likewise will change more gradually if the wood contains appreciable amounts of moisture, since much heat is utilized to evaporate the water. The faster coaling action likely to develop with dry wood means excessive temperatures and amounts of gas, with resultant greater possibilities for kiln fire or explosion.

Obviously, the drier the wood, the more closely must coaling be controlled if the hazard of explosion and fire is to be held down. From a safety standpoint, therefore, as well as for most efficient coaling, wood should be between about 30 and 40 percent in moisture content.

Particular care should be taken in igniting a kiln charge by the open-door method, since the highly flammable fuel oil and abundance of air set off



**vigorous and spreading combustion at once. There is especially great danger here of suffering burns from the sudden flaming until the door is closed. Gloves should be worn when working near the kiln door, and workmen should be careful about tripping or falling against heated surfaces during ignition or coaling periods.**

**While combustion is less spontaneous and widespread when a charge is ignited by the closed-door method, it is equally necessary that safety be kept in mind at all times. Fuel oil commonly used for ignition purposes should be poured over the fuel bed immediately before it is ignited, because back-fire and explosion can easily occur if oil fumes are allowed to accumulate in a kiln that is practically closed. Gasoline or similar fuels with low flash-point should never be used. Structural cracks and other openings that occur during coaling can usually be detected by the smoke escaping through them. They should be repaired at once, since during the cooling period no air should enter the kiln. Even a little air will prevent proper cooling to take place.**

**Oil- and gas-burning torches used to ignite a charge can cause overheating, which in turn can lead to structural damage and too fast coaling. There is always, moreover, the possibility the burner may cause an explosion. Incomplete combustion or mechanical failure of the burner is particularly hazardous. Raw fuel oil ejected by a malfunctioning burner can quickly vaporize within the kiln, setting up a critical explosion condition. Proper use and understanding of such equipment is therefore of highest importance.**

**When the ceiling of a sand-sealed, flat-ceilinged structure is being inspected or repaired, workmen should stand on long planking supported by the ceiling framework. Heavy gloves should be worn for protection from burns by hot sand or metal.**

**Poisonous gases are present in a kiln that has just been cooled. The kiln should be thoroughly ventilated before entering it and all during the time it is occupied. Dust masks should be worn when charcoal is handled in confined areas. Dust can be held down by sprinkling the cooled charcoal with water before unloading the kiln.**

**Orderly housekeeping methods are recommended because they contribute to efficient management.**

### **Charcoal Storage Precautions**

**The highly seasonal demand for charcoal in most parts of the country makes it necessary either for producers to stockpile a considerable inventory, which is expensive, or to stop operations temporarily.**

**A great deal of care must be taken in storing charcoal. Although the product is very stable when properly cooled, it can be hazardous when handled otherwise. There is danger also that this easily combustible material, when stock-piled in any amount, will be ignited by other sources of fire. It is always best practice to screen the charcoal for removal of fines before storage, whether for short or long periods of time.**

**Although spontaneous combustion (self ignition by generation of heat through chemical action within the charcoal) is always a possibility, a much more common cause of fire during storage is so-called "hot" charcoal. Such charcoal consists of hot or even actively burning pieces that escaped notice when the charge was removed from the kiln. Spontaneous combustion may occur also in masses of charcoal water sprayed for rapid cooling. It is advisable, therefore, that freshly discharged charcoal be placed in the open away from previously cooled and conditioned charcoal for at least 24 hours. During this time, it should be exposed to good air circulation and protected from rain, preferably in an open shed rather than under a tarpaulin or in too confined a space. If there is no evidence of heat or active fire after this cooling period, the charcoal can be considered safe for warehouse storage.**

**Tightly packed masses of charcoal fines are more subject to spontaneous combustion than the larger lump material. Whether in containers or in bulk piles, fines should be exposed to the air but protected from rain for not less than 5 days before being placed in more confined storage or shipped out. Fines should be stored separately from lump charcoal.**

### **Charcoal Yield and Production Factors**

#### **General**

**The importance of yields and their accurate determination in charcoal production cannot be over-emphasized. The amounts of charcoal obtainable from the raw material available should be carefully considered by anyone planning to start or, for that matter, to continue an operation.**

**The true value of charcoal is a matter of both quantity and quality. While charcoal is sold mainly by weight, its quality is largely the reason for repeat sales--or loss of markets to competitors. The quality of lump charcoal can be roughly determined by such physical properties as hardness, brittleness, and density. It can be better defined by chemical composition--that is, the amounts of fixed carbon, ash, and volatiles charcoal contains (50). The determination of quality on the chemical basis is highly important to producer and consumer alike in the marketing of either lump or briquette charcoal.**

## Measuring Yield by Charcoal Percentage

A suitable method of measuring the yield is to divide the weight of the charcoal recovered by the calculated weight of the oven-dry wood used. This gives a figure that, when multiplied by 100, gives the percentage of wood converted to charcoal.

Weighing the wood charged rather than measuring its volume eliminates the effect of such variables as species density and stick size and form. Likewise, calculation of the weight of the oven-dry wood removes the variable of moisture content, as between green and dry wood, and tells exactly the amount of wood available for charcoal production.

Ordinarily, no weight allowance for moisture content is made for charcoal that has been cooled by natural radiation and unloaded in dry weather. Charcoal made experimentally at northern locations averaged 2.3, and that at southern kilns 2.4 percent moisture content. Moisture content levels much under 3 to 4 percent, no matter how precisely measured, would probably be offset by errors in sampling of charcoal and wood for moisture content. If the moisture content of the charcoal has been raised as a result of water cooling or during prolonged bulk storage under high humidity conditions, a determination of moisture content is necessary to obtain a useful yield value.

## How to Determine Charcoal Conversion

Wood moisture content. - - Commercial electric moisture meters are suitable for measuring moisture content if the wood is well seasoned. These instruments are reasonably accurate within a range of about 7 to 30 percent.

By another method, moisture content is determined on 1-inch-thick sections cut from a representative number of the pieces in the charge. These sections should be weighed as soon as cut or wrapped in foil or sheet plastic to maintain their moisture content until they can be weighed. The weighings should be made to the nearest tenth of a pound.

Dry the weighed sections at a controlled oven temperature of about 212° F. for at least 12 hours and weigh them again. If the sections do not change weight after one or two 12-hour intervals of further drying, all of the moisture they contained has been removed.

The moisture content of each wood section is calculated as follows:

$$M. C. = \frac{\text{weight when cut} - \text{oven-dry weight}}{\text{oven-dry weight}} \times 100$$

The average moisture content of all the sections is then determined.

**Charcoal moisture content.** - The moisture content of charcoal may be determined by the drying-oven method as outlined for wood. Dry the charcoal in an open container, weigh it, and subtract the weight of the container from the total weight to obtain the oven-dry weight of the charcoal. Avoid drying temperatures in excess of 212° F. An imported moisture tester for charcoal has recently become available (appendix).

In establishing the weight of the oven-dry wood in the charge, the wood is weighed as the kiln is loaded. This weight is used for calculating the weight of the oven-dry charge by applying the method for average moisture content previously described. The weight of the charge when oven-dry is determined as follows:

$$\frac{\text{weight of wood in kiln}}{\text{average moisture content of sections} + 100} \times 100$$

The charcoal yield is determined in percent as follows:

$$\text{Percent charcoal conversion} = \frac{\text{weight of charcoal}}{\text{calculated oven-dry weight of wood}} \times 100$$

**Quantity measurements.** - It is not always possible to weigh the wood, nor is it always economical to do so when wood is purchased on a volume basis. In such cases, charcoal yields may be determined from calculated values for weight of wood by the cord. The accuracy of this method will depend upon the number of raw material variables that can be controlled.

The standard cord generally accepted in the United States and Canada is 4 by 4 by 8 feet. A cord of roundwood contains, therefore, 128 cubic feet of wood, bark, and voids (25). The weight of the wood in a cord depends, in turn, upon wood density and the diameter and form of the sticks. Since wood varies considerably in density within a species as well as among species, and size of sticks also varies a great deal, such estimates of cord weight can only be approximate. This indirect method for obtaining wood weight is discussed further elsewhere in this report.

Charcoal yield by weight can be estimated by measuring the number of bushels obtained per cord of wood and using arbitrary bushel weights of 20 and 18 pounds for hardwood and softwood charcoals, respectively. Charcoal weights obtained in this manner are subject to considerable error because of

inaccurate measurement by the bushel, the variability of charcoal itself, and the rough approximation inherent in estimates of wood weight by the cord.

**Charcoal quality.** - - The amounts of moisture (2 to 4 percent), volatiles (18 to 23 percent), ash (1 to 4 percent), and fixed carbon (74 to 81 percent) in charcoal provide an average index of quality for general market acceptance either in lump or briquette form (50). Charcoal with relatively low volatile content and correspondingly higher amounts of fixed carbon is desirable for specialized industrial uses. Temperatures somewhat higher than the normal kiln operating temperatures of 850° to 950° F. are required to produce it. The volatiles, when present in proportions greater than about 24 percent, will cause smoking when charcoal is burned and will give product degrade in some areas of recreational use.

Chemical properties can be precisely determined only with analytical equipment. A rough quality test for volatiles can be made, however, by burning samples of charcoal and observing the absence or extent of smoking. A metallic ring when a piece of charcoal is dropped onto a hard surface provides a further rough test for good quality. Too rapid cooling at high temperature usually results in the formation of crumbly charcoal easily broken into small pieces and fines. The species of wood does not influence the chemical quality of charcoal; the physical properties, however, are influenced by wood density and structure. For example, the low-density woods produce charcoal in greater bulk, while some woods will produce brittle charcoal. In general, the lump charcoal obtained from the medium-dense to dense hardwoods is considered a cleaner product because of less breakage and dusting with handling.

### **Effects of Operating Conditions on Yield**

Charcoal yields are affected by variables within the kiln charge and by the cooling conditions employed. The quality of the charcoals varies likewise with change of operational conditions. A summary of the results obtained in field studies, with reference to other research, points out the relationship of charcoal yields to some of these major variables.

### **Wood Moisture Content and Yield**

The yield of charcoal varies with major changes of wood moisture content. More of the wood in a charge is consumed for drying when cooling unseasoned than seasoned wood, consequently there is less charcoal. Experiments with seasoned hard maple at 32 percent moisture content coaled in 3-cord kilns resulted in a 30 percent yield of charcoal. Similar charge material at 44 percent moisture

content was converted in a yield of 27 percent. Other comparable experiments on mixed northern hardwoods at 47 percent moisture content resulted in yields of about 25 percent.

Six more experimental runs in a 7-cord kiln, using white oak and hickory at 36 percent moisture content, resulted in 33 percent conversion, or an average yield of 910 pounds of charcoal per cord. Ten further runs, using wood averaging 63 percent in moisture content, resulted in 29 percent conversion, or a yield of 792 pounds per cord. The variations in moisture content had no effect on charcoal quality.

There appears to be sufficient difference in yields from the coaling of unseasoned and seasoned wood to make moisture content an important factor in kiln operation. Whether to use unseasoned wood with reduced charcoal yield or take on the extra stacking and handling costs for seasoning is something each operator must decide for himself.

### Wood Moisture Content and Conversion Time

In connection with the coaling pattern, three general groupings of wood by moisture content can be made: Wood air seasoned to within the range of 20 to 35 percent moisture content generally requires the shortest coaling cycle; wood at 35 to 45 percent requires a median coaling cycle, while wood at a moisture content of 45 percent or more (unseasoned) the longest (82). Wood with less than 20 percent of moisture is likely to coal too rapidly, and care must be taken to avoid development of excessively high temperatures.

The results from the operation of both the 3- and 7-cord experimental kilns indicate that the average coaling time for seasoned wood was 4 to 5 hours per cord and that for unseasoned wood, 5 to 8-1/2 hours per cord.

### Wood Moisture Content and Brands

A charge of unseasoned wood is more difficult to convert completely than one of seasoned wood. Some "brands," pieces not wholly charred, are generally found near the kiln floor, where the usually lower temperatures prevent uniform coaling at an average rate.

Brands were present in most of the experimental runs. In a 7-cord kiln, seasoned oak wood produced 97 pounds and unseasoned oak 260 pounds per cord on the average. In a 3-cord kiln, 358 pounds of brands were produced from seasoned hard maple and 481 pounds from unseasoned hard maple.

These weights included the moisture remaining in the brands and therefore the number of brands would be relatively small. The higher weight ratio of brand material to charcoal from the 3-cord kiln runs cannot be clearly related but may be due to variation in kiln size and to minor differences in coaling procedure. In these series of runs, the charges of wood were at comparable moisture content levels.

Effect of Wood Species, Form on Weight of Charge

The yield of charcoal from a kiln is directly related to the density of the wood charged. As a general rule, then, the denser or heavier the wood used, the greater will be the weight yield. Even within some species, as among the oaks and hickories, there is variation in the weight of dry wood per cubic foot. This variation in the oven-dry weight per cubic foot--for a number of species is shown in table 3. An indication of the effect of wood density on yields for heavy and light species is given in the coaling results from a 7-cord kiln (table 4).

Table 3.--Weight of various species when oven-dry (74)

Species	Oven-dry weight	Species	Oven-dry weight
	Lb. per cu. ft.		Lb. per cu. ft.
Alder, red <sup>1</sup>	27	Longleaf pine <sup>4,2</sup>	39
Ash, white <sup>2</sup>	40	Madrone <sup>3</sup>	43
Aspen <sup>1</sup>	26	Maple, red <sup>2</sup>	34
Basswood <sup>1</sup>	25	Maple, sugar <sup>3</sup>	43
Beech <sup>3</sup>	42	Mesquite <sup>3</sup>	50-60
Birch, yellow <sup>3</sup>	41	Oaks <sup>3</sup>	42-52
Cottonwood, east. <sup>1</sup>	27	Redwood <sup>1</sup>	26
Douglas-fir (coast) <sup>2</sup>	32	Shortleaf pine <sup>2</sup>	33
Hemlock <sup>1</sup>	27	Slash pine <sup>4,2</sup>	41
Hickories <sup>3</sup>	42-52	Sweetgum <sup>2</sup>	34
Juniper <sup>2</sup>	34	Tupelo <sup>2</sup>	34
Loblolly pine <sup>2</sup>	34	Walnut <sup>2</sup>	35
Lodgepole pine <sup>1</sup>	27		

<sup>1</sup>Grouped as light species.

<sup>2</sup>Grouped as medium-heavy species.

<sup>3</sup>Grouped as heavy species.

<sup>4</sup>Average resin content approximates 6 to 8 percent.

**Table 4.--Variation of wood weight and charcoal yields<sup>1</sup>**

Species	: Runs	:	Charcoal	:	Yield
			<u>Lb. per cord</u>		<u>Percent</u>
Light hardwoods	: 3	:	670	:	30.9
Southern red oak	: 16	:	820	:	29.6
Mixed oak and hickory	: 11	:	850	:	29.2
Hickory	: 1	:	920	:	27.9

<sup>1</sup>Based on 31 runs in 7-cord masonry block kiln.

The form of the wood will influence the weight charged and likewise the weight of charcoal produced. Straight roundwood has favorable form for good piling and therefore provides the more solid material per cord. The wide range of wood weights that is possible because of species differences and piled solid wood per cord is shown in table 5, together with related charcoal yields.

The effect of wood form on piled kiln charges has been noted in experimental operation. The dry weight of southern red oak in a fully charged 7-cord kiln (6.6 cords, actual volume) varied from 2,350 to 3,250 pounds per cord. The amounts of dry wood that it was possible to load into the kiln thus varied by about 3 tons, depending chiefly upon stock diameter and straightness. This difference of wood weight represents about 1,800 pounds of charcoal.

The dry weight of sugar maple that could be put in a S-cord kiln (actual volume, 2.7 cords) ranged from 2,260 to 3,030 pounds per cord. The difference of 2,100 pounds of wood in this case amounts to somewhat over 600 pounds of charcoal per kiln charge. Since there was a wood weight difference of but little more than 100 pounds per cord between the southern oak and sugar maple, it would indicate that the maple sticks were somewhat straighter and more uniform.

Differences in wood form and size--for example, roundwood, slabwood, and chunkwood - - also cause differences in kiln charge weights. Indications of this are shown in the results obtained in loading experimental kilns with different types of raw materials (table 6).



Table 5.--Relationship of calculated wood volume-charcoal yields  
by various species<sup>1</sup>

Species	65 cubic feet of wood and bark per cord		85 cubic feet of wood and bark per cord	
	Ovendry weight per cord	Charcoal yield	Ovendry weight per cord	Charcoal yield
	<u>Pounds</u>	<u>Pounds</u>	<u>Pounds</u>	<u>Pounds</u>
Alder, red	1,755	561	2,295	734
Ash, white	2,600	832	3,400	1,088
Aspen	1,790	573	2,210	707
Basswood	1,625	520	2,125	680
Beech	2,730	873	3,570	1,142
Birch, yellow	2,665	853	3,485	1,115
Cottonwood, east.	1,755	561	2,295	734
Douglas-fir (coast)	2,080	666	2,720	870
Hemlock	1,755	561	2,295	734
Hickories	2,730-3,380	874-1,081	3,570-4,420	1,142-1,414
Juniper	2,210	707	2,890	925
Loblolly pine	2,210	707	2,890	925
Lodgepole pine	1,755	561	2,295	734
Longleaf pine	2,535	821	3,315	1,060
Madrone	2,795	894	3,655	1,169
Maple, red	2,210	707	2,890	925
Maple, sugar	2,795	894	3,655	1,169
Mesquite	3,250-3,900	1,040-1,248	4,250-5,100	1,360-1,632
Oaks	2,730-3,380	874-1,081	3,570-4,420	1,142-1,414
Redwood	1,790	573	2,210	707
Shortleaf pine	2,145	686	2,805	897
Slash pine	2,665	853	3,485	1,115
Sweetgum	2,210	707	2,890	925
Tupelo	2,210	707	2,890	925
Black walnut	2,275	728	2,975	952

<sup>1</sup>Based on 32 percent conversion to charcoal.

**Table 6. --Influence of type of raw material on weight of kiln charge**

Mill residues		:	Roundwood	
Species and type	Average ovendry weight	:	Species	Average ovendry weight
	<u>Lb. per cord</u>	:		<u>Lb. per cord</u>
Sugar maple flooring trim	2,500	:	Sugar maple	2,600
Sugar maple slabs	2,200	:	Basswood	1,450
Sugar maple slab chunks <sup>1</sup>	2,000	:	Mixed soft hardwoods	2,150
Northern red oak slabs	2,250	:	Hickory	2,950
		:	Mixed southern oaks	2,800

<sup>1</sup>Length, 1 to 1-1/2 feet.

Sawdust, chips, and shavings are not suitable raw materials for kiln charcoal. In loose or compacted masses of such materials, heat is transmitted with difficulty and, while coaling is possible, it can be carried out only in a very inefficient manner.

**Effect of Species, Form on Charcoal Yield, Quality**

Satisfactory charcoal yields were obtained experimentally with various wood species and forms. The hardwood flooring trim, which was the smallest material coaled, gave yields of 30 percent. This yield is suitably high but will increase or decrease with the amount of solid material charged, since this factor noticeably affects the charcoal yield per kiln charge.

Given proper coaling conditions, all wood species will produce good-quality charcoal with comparatively high fixed carbon content. All species included in the field experiments were converted to good-quality charcoal with 75 to 82 percent of fixed carbon. This was equally true in the coaling of the slab, flooring trim, and chunk forms of raw material. The species used singly or in groups were sugar maple, mixed northern hardwoods, basswood, southern oaks, mixed southern hardwoods, and hickory.

### Effect of Kiln Size, Type on Charcoal Yield, Quality

There has been little direct information developed regarding the effect of kiln size on the coaling pattern or charcoal yield. No serious attempt was made in the field studies to develop such information because of wide variation in type of structure, raw material, and operating methods. Where a measure of comparison was possible in the operation of kilns ranging from 2- to about 10-cord capacity, it appeared that the larger have a production advantage during a given period of time. Hicock (35) reports that kilns of 5- to 12-cord capacity appear capable of greater production per cord of wood than the smaller units. One possible explanation is that oversize wood can be more successfully carbonized in the larger kilns.

Further indications of greater yields from these larger kilns are obtained by comparing coaling results from 3- and 7-cord experimental units. Whether seasoned and unseasoned wood was used, charcoal production from the 3-cord units was measurably less than from the 7-cord units. The yield difference is not clear cut, however, since operating conditions have not always been the same in kilns of both sizes.

Charcoal of satisfactory market quality can be made in kilns of any size or type when suitable coaling temperature and time conditions are present. It is perhaps more difficult to produce charcoal of consistently high quality in uninsulated metal kilns because of rapid and large heat loss.

### Effects of Kiln Size, Type on Production Time

When raw materials, operational methods, and coaling temperatures are the same, the coaling time per cord of wood is also roughly the same for kilns of various sizes and of generally similar types. Experimental runs made in 3- and 7-cord multiwall kilns indicated, for example, coaling periods of about 4 hours per cord of seasoned and 7 hours per cord of unseasoned wood. Differences in the time for loading and unloading kilns might well be a more important factor in production, depending upon the equipment available and its suitability for use *with a kiln of given size and type*.

### Effect of Time, Temperature on Coaling and Charcoal Quality

Good-quality charcoal is obtainable at kiln temperatures of 850° to 950° F. The amount of fixed carbon will increase at higher kiln temperatures, accompanied by a corresponding decrease in charcoal yield. With somewhat

lower than normal coaling temperatures, a longer time is required to produce charcoal of acceptable quality.

Because it would not be practical to place as many thermocouples in commercial kilns as were used in the experimental units, the average temperature range of 850° to 950° F. at the ceiling has been mainly used for the coaling control. The average temperature of the hotter gases at the ceiling is a simple indicator of coaling conditions. This average temperature does not, however, represent an overall kiln temperature, since the wood nearer the kiln floor may not coal until later in the cycle, and then usually at a temperature somewhat lower than that of the wood closer to the ceiling.

The average kiln temperature affecting both the quality and quantity of charcoal produced varies, therefore, with the rate of coaling. The sooner there is conversion of the wood in the lower part of the charge, the greater will be the trend toward higher overall temperatures, as has been experimentally verified by numerous thermocouples placed throughout a charge.

As shown in figure 34, the kiln ceiling temperatures follow much the same pattern as the overall temperatures. The average difference between ceiling and overall temperatures was greater during the winter. This difference was also greater during the coaling of unseasoned than seasoned wood, and hence it *may* be that in colder weather charges of unseasoned wood might more advantageously be coaled at the higher temperatures in the 850° to 950° F. range. During the summer, on the other hand, seasoned wood might be coaled to best advantage at the lower temperatures in this range.

The effects of time and temperature on coaling at different levels within the charge bears closely on the quality of the charcoal produced within each level, or zone. Relatively high coaling temperatures must be kept in the upper zones if the temperatures in the lower zones are to be sufficiently high for efficient carbonization. The results from 16 runs on southern oak indicated that the top zone of the undisturbed charcoal contained about 85 percent of fixed carbon, the center zone about 80 percent, and the zone near the floor 75 to 79 percent. Proper sampling for analysis requires that a sufficient number of samples be taken from a part or all of the kiln charcoal so that a representative collection of samples is obtained.

Table 7 shows that charcoal of higher fixed carbon content was produced at average ceiling temperatures above 875° F. Although the difference between the lower and higher ceiling temperatures is slight, there is indication, nevertheless, of a close relation between temperature and quality. With greater variation in temperature, a wider spread in quality values would likewise be expected.

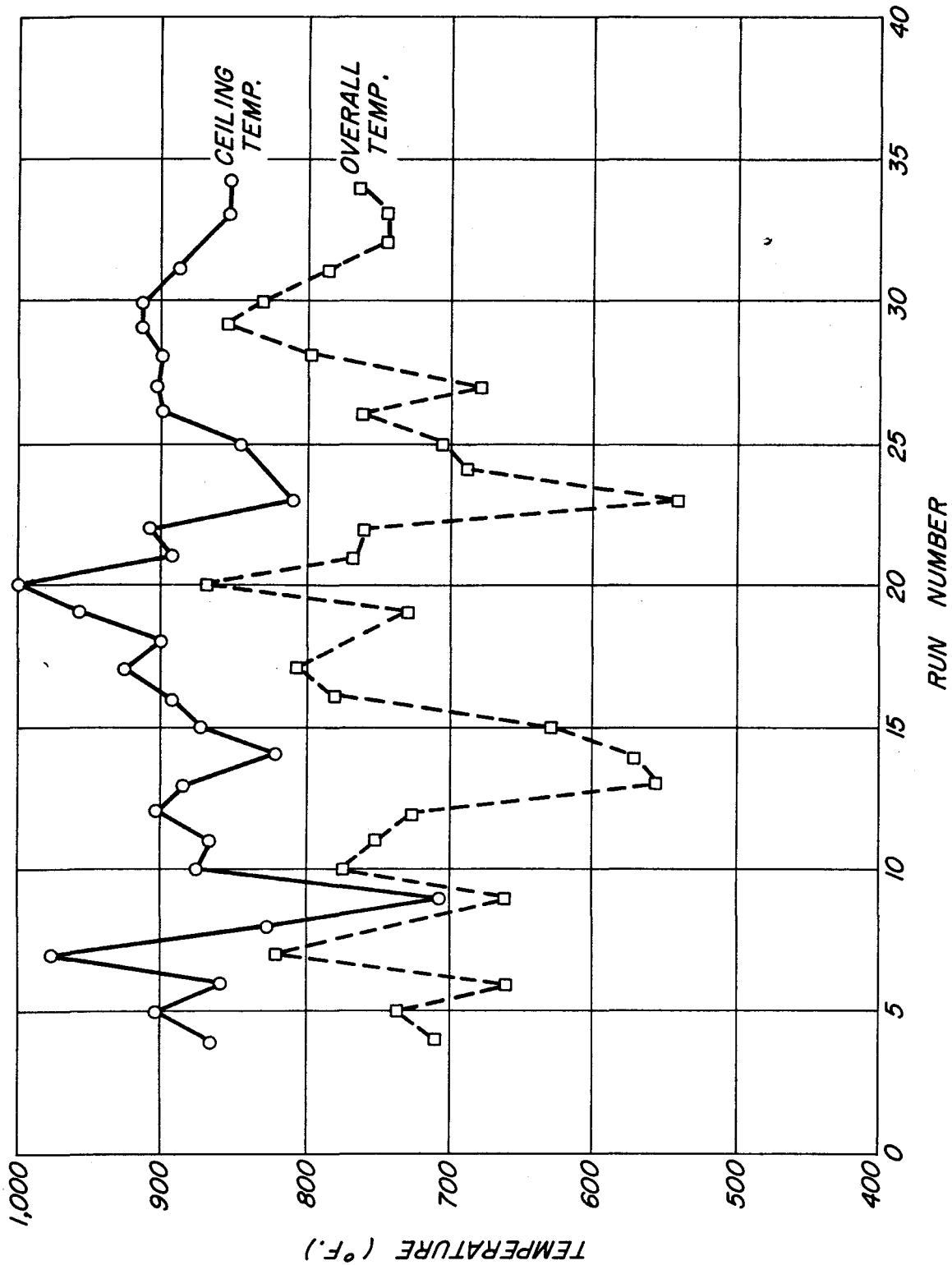

Figure 34. -- Comparison of average ceiling and overall temperatures in experimental kiln operation.

Z N 118 349

Table 7.--Relation of yields and fixed carbon content of charcoal obtained at different ceiling temperatures

Number of runs:	Ceiling temperatures:	Average ceiling temperature:	Average overall temperature:	Moisture content:	Coaling time:	Fixed carbon:	Yield:
:	:	°F.	°F.	Percent	Hours	Percent	Percent
UNSEASONED							
7	: Below 875° F.:	840	660	62	49	82.2	27.9
13	: Above 875° F.:	910	748	59	41	83.8	28.2
SEASONED							
4	: Below 875° F.:	857	725	38	36	80.7	31.3
5	: Above 875° F.:	922	822	36	31	82.0	33.1
AVERAGE - UNSEASONED AND SEASONED							
11	: Below 875° F.:	845	680	54	45	81.8	28.9
18	: Above 875° F.:	913	777	53	38	83.5	29.5

At operating temperatures above about 900° F., correspondingly lower charcoal yields are expected. The yields from a number of experimental runs have been found to be otherwise, where the higher ceiling temperatures were not necessarily associated with lower yields (table 7). Instead, a slightly higher yield was obtained, which may be due in part to the fact that the runs were more complete (with fewer brands) at the higher temperatures, as pointed out previously.

To compare results further, these 26 experimental runs are grouped as unseasoned and seasoned wood charges converted at average ceiling temperatures both above and below 875° F. (table 7).

### Effects of Time, Temperature on Kiln Operations

As a rule, there is little control of coaling time when a kiln is operated within a set temperature range. The important object is to obtain as complete coaling as possible. One way to determine when coaling is complete is by observing smoke volume. When smoking practically stops, coaling is complete. When smoking ceases, also, the average kiln temperature will have approached a level of about 800° F.

With well-seasoned wood, coaling time will be fairly uniform from run to run. The coaling of green wood is less uniform to such an extent that similar kiln charges may vary greatly in the amount of time needed for completion (fig. 35). The period of time required for coaling 6.6 cords of seasoned wood varied from 28 to 33 hours, and the time for green wood from 34 to 55 hours, in a 'I-cord kiln. In a 3-cord unit, seasoned wood required 11 to 17 hours and unseasoned wood 11 to 28 hours (84). In table 7 it is also indicated that the average coaling time is slightly reduced with higher average ceiling temperatures. Control steps suitably applied resulted in generally satisfactory yields of good-quality charcoal under the various study conditions.

A further condition possibly affecting yields is cold, windy weather, as indicated by the results given in table 8. Run No. 2 provided mostly brands, even though overall kiln temperatures (based on previous satisfactory runs) suggested coaling had been carried to completion.

### Effect of Time Temperature on Brands

Production of brands is not unusual in kiln operation. They are produced in varying amounts in different kilns. It is not possible to state any exact cause or overall corrective measure. The results in table 9, from data mentioned

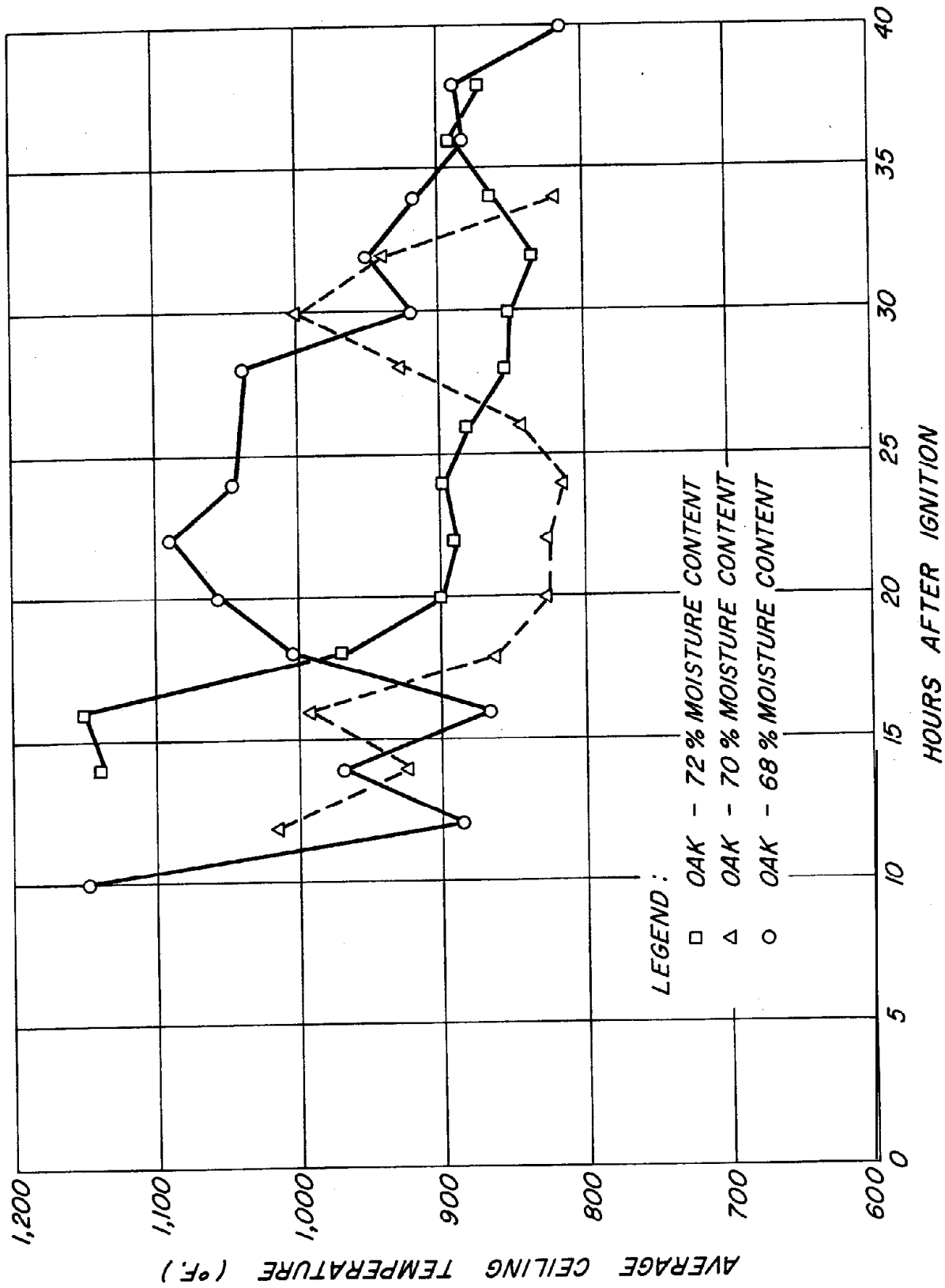

Figure 35. --Average ceiling temperatures obtained during the cooling of unseasoned wood.

ZM 118 347



previously, indicate, however, that less brand material is produced from unseasoned wood at the higher average ceiling temperatures. The longer average coaling time for unseasoned wood appears not as effective for brand weight reduction as does a slightly higher average coaling temperature, based on the results from 26 runs in a 7-cord masonry-block kiln.

### Effect of Weather on Charcoal Yield

Marked changes in seasonal temperatures affect yield. Reportedly, metal kilns (9, 10, 11, 12) operated during the colder weather of November and December produced only 86 percent of the charcoal by volume, obtained from similar runs conducted during the warmer months of May to September. Yield was also reduced in a 7-cord masonry-block kiln during 9 experimental runs made in the November-to-April period compared to 10 carried out in the period of May to October. The average moisture content of the wood in each group of runs was quite similar, 58 and 63 percent. The runs likewise were kept similar in operation. The coaling temperatures near the kiln ceiling were maintained, as closely as possible, within the range of 850° to 950° F. The average conversion was 27.6 percent for the cold-weather runs and 28.7 percent for those made in warmer weather. There was, too, a wide range in conversion percent for the runs, indicating other factors were masking the results. The 1.1 percent variation indicated in these experimental results amounts to 11 percent of the total possible conversion difference. This difference is taken from average low and high conversion values of about 24 to 34 percent. This difference accounts for an average of 200 pounds per run, or the loss of about 1 ton of charcoal for the runs conducted in the colder weather.

### Effects of Weather on Carbonization Temperature

Charcoal of good quality can be made in kilns at any time of the year provided proper coaling temperatures are maintained. With the greater loss of heat from the metal kilns, suitable operation would be more difficult in the colder seasons. If the temperature is maintained at too low a level during the length of the usual coaling cycle, a lower quality product will result.

In kiln production a coaling pattern usually develops that may change somewhat from run to run. Even with closely directed control, it is difficult to predict a certain average ceiling temperature because of normal variation within a suitable temperature range. With air intake reduced to the lowest workable level, it is not always convenient or practical to regulate the

**Table 8. --Charcoal yield from sugar maple roundwood in a 3-cord, masonry-block kiln, using end firing and two stacks**

Run No.:	Time of year	Wood moisture content	Run time	Kiln temperature (average overall)	Charcoal Yield per cord	Brands		
2	:December	45	: 11	: 665	: 282	: 13.0	: 77.97	: 1,478
3	:December	43	: 18-1/2	: 647	: 658	: 29.8	: 81.55	: 306

**Table 9.- Comparison of charcoal and brand yields at different ceiling temperatures**

Wood carbonized at average ceiling temperature below 875° F.		Wood carbonized at average ceiling temperature above 875° F.					
Moisture content (average)	Average ceiling temperature	Yield per cord (average)	Brands per cord	Moisture content (average)	Average ceiling temperature	Yield per cord	Brands per cord
(Unseasoned): 62	840	27.9	335	59	910	28.2	232
(Seasoned) 38	857	31.3	123	36	922	33.1	115

amount of air in order that the temperature can be maintained within a 100° F. range. It is necessary, on the other hand, that care be taken to prevent prolonged high temperatures.

In one series of tests, the November-April runs coaled at a lower average ceiling temperature than the May-October runs (fig. 36). This would indicate that colder air and more rapid heat loss have an effect on the process of coaling, even though operational procedures might be judged to be similar. While a temperature difference of 53° F., as indicated, is not great, the temperature at the kiln ceiling was kept between 850° and 950° F. Moreover, the coaling chamber was relatively well insulated, in that two-thirds of the experimental structure was double-wall, masonry-block construction. These winter experiments were made in the South. It can be assumed, therefore, that a greater temperature difference, with more heat loss, would be found in the operation of kilns under more severe weather conditions in the northern states.

### Economic Studies

How wood price, labor charges, and other factors, such as operational efficiency, yields, and kiln types, affect production costs of charcoal was investigated in two kinds of field studies.

A considerable volume of charcoal is produced in both the portable sheet-metal and masonry kilns. To provide more information on their relative performance, one study of wood and labor-time charges and charcoal yields was made with metal units of 1/2- and 1-1/2-cord capacity and a masonry unit of 2-cord capacity. Similar time and yield data developed from the operation of a 7-cord masonry kiln at another location were included to compare the effects of kiln size.

In another study, quite different information was developed. This work was done to indicate possibilities for combining kiln production and forest management. An efficiently operated 7-cord masonry kiln capable of producing uniformly good yields of charcoal was used as a study control factor. The major elements of wood and labor costs were investigated with relation to production cost. A production cost based in large part on these costs would indicate what the break-even point is with respect to various charcoal prices. The chief object of the study was to gain information on the break-even point.

The most favorable combined operation obviously would be conversion of the improvement cuttings at a cost under the average charcoal selling price. On the other hand, even if only break-even costs were met by charcoal sales, the operation would defray stand improvement charges without continued investment.

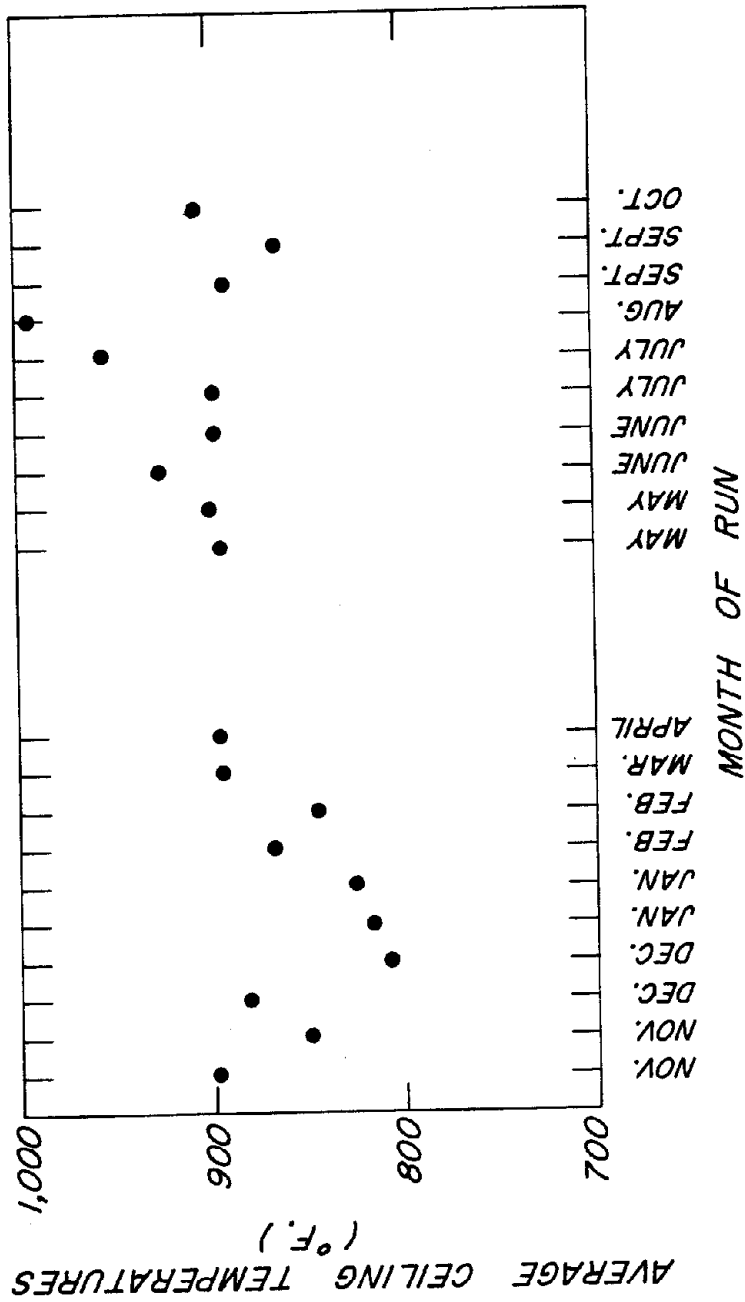

**Figure 36. -- Comparative coaling temperatures for runs conducted during different seasons using unseasoned wood.**

ZM118340

## **Kiln Comparison Study**

The 7- and 2-cord masonry kilns, of the three types employed, produced the higher yields and sustained the least depreciation (90). For these reasons, they appeared the most profitable ones to operate, even though the labor cost during the coaling and cooling periods was higher. At then current prices for wholesale charcoal, none of the kilns showed an adequate margin of profit. Higher profits might accrue through the use of low-cost wood, larger kilns, batteries instead of single kilns, and mechanization of the handling of wood and charcoal.

Conditions for this study included fixed charges of \$12 per cord at kiln site for the red oak roundwood, \$1 per hour for labor, and production depreciation cost at 5 percent interest per ton of charcoal produced. Average cost of the metal kilns was determined as \$600 and that of the block kilns \$200. Their life was estimated at 200 runs.<sup>5</sup> Other fixed charges for overhead, maintenance, profit, and risk were purposely not included, since these costs differ widely with local conditions, operating and marketing methods, and desired returns.

In order to keep labor charges at efficient levels, it was assumed that a sufficient number of kilns of each type (figs. 4, 18) would be operated simultaneously to keep two men employed full time. On a 40-hour week basis, this would make necessary roughly the use of twelve 1/2-cord or five 1-1/2-cord metal kilns, or three 2-cord masonry kilns.

The different types of units were operated according to standardized procedures. All but one of the 1/2-cord kilns were thermocouple wired for temperature and permitted to cool at any temperature common to commercial practice. The masonry kiln was operated at a temperature not exceeding 950° F. Both raw material and product were weighed for all runs. The time for labor charges was on the basis of man-hours consumed for the various kiln-run jobs.

Generally lower charcoal yields can be expected with uninsulated, metal kilns compared to those with more effective heat barriers, as, for example, masonry kilns. The results indicated an appreciable difference of about 7 percent in charcoal weight yield in favor of the masonry kiln operation, which suggests corresponding lower costs of converting wood to charcoal. The direct labor costs in this one study varied only from \$23.35 for the 1-1/2-cord

---

<sup>5</sup>The life of the masonry kilns used experimentally is unknown. Some commercial masonry kilns have reported records of 150 to 200 runs. The very rough estimate of a 200-run life is therefore based on speculation, not actual performance.

metal unit to \$26.12 for the 1/2-cord metal unit per ton of charcoal produced. Break-even costs developed on the basis of fixed charges for wood, labor, and depreciation are shown in table 10.

**Table 10.- Break-even production costs for three kinds of charcoal kilns**

Kiln type:	Kiln capacity:	Cost per ton of charcoal			
		Labor	Wood	Depreciation	Total
	<u>Cords</u>				
Metal	1/2	\$26.12	\$28.68	\$6.25	\$61.05
Metal	1 - 1/2	23.35	35.73	4.42	63.50
Masonry	12	24.05	24.73	3.44	52.22

<sup>1</sup>Extension of these data to the operation of an experimental ii-cord masonry kiln indicated a production cost of \$43.25 per ton.

The relationship of data obtained on wood cost per cord to charcoal production cost per ton is graphically shown in figure 37. Assuming a break-even cost of \$50 a ton, roughly \$7.50 a cord for dense hardwoods would be the highest price that could be met with operation of the metal kilns. This relationship can be seen by following the dashed line vertically from \$50 on the base line (production cost per ton of charcoal) to its intersection with the cost curves for the two metal kilns. Extension of this dashed line horizontally from the intersection to a point on the vertical base line (wood cost per cord) indicates a cost per cord of nearly \$7.50. Carrying the vertical dashed line upwards until it intersects with the cost curves for the two masonry kilns and then horizontally to the left to the vertical base line, maximum wood costs of \$11 and \$13.50 per cord are shown for the 2- and 7-cord kilns, respectively. Figure 37 also shows that lowering the cost to about \$5 for a cord of the raw material, which is roughly the cost of mill slabwood, will effectively reduce the cost of producing a ton of charcoal in all three types of kilns. Some lowering of production costs might be possible, likewise, by more efficient use of labor through mechanization of the handling of materials.

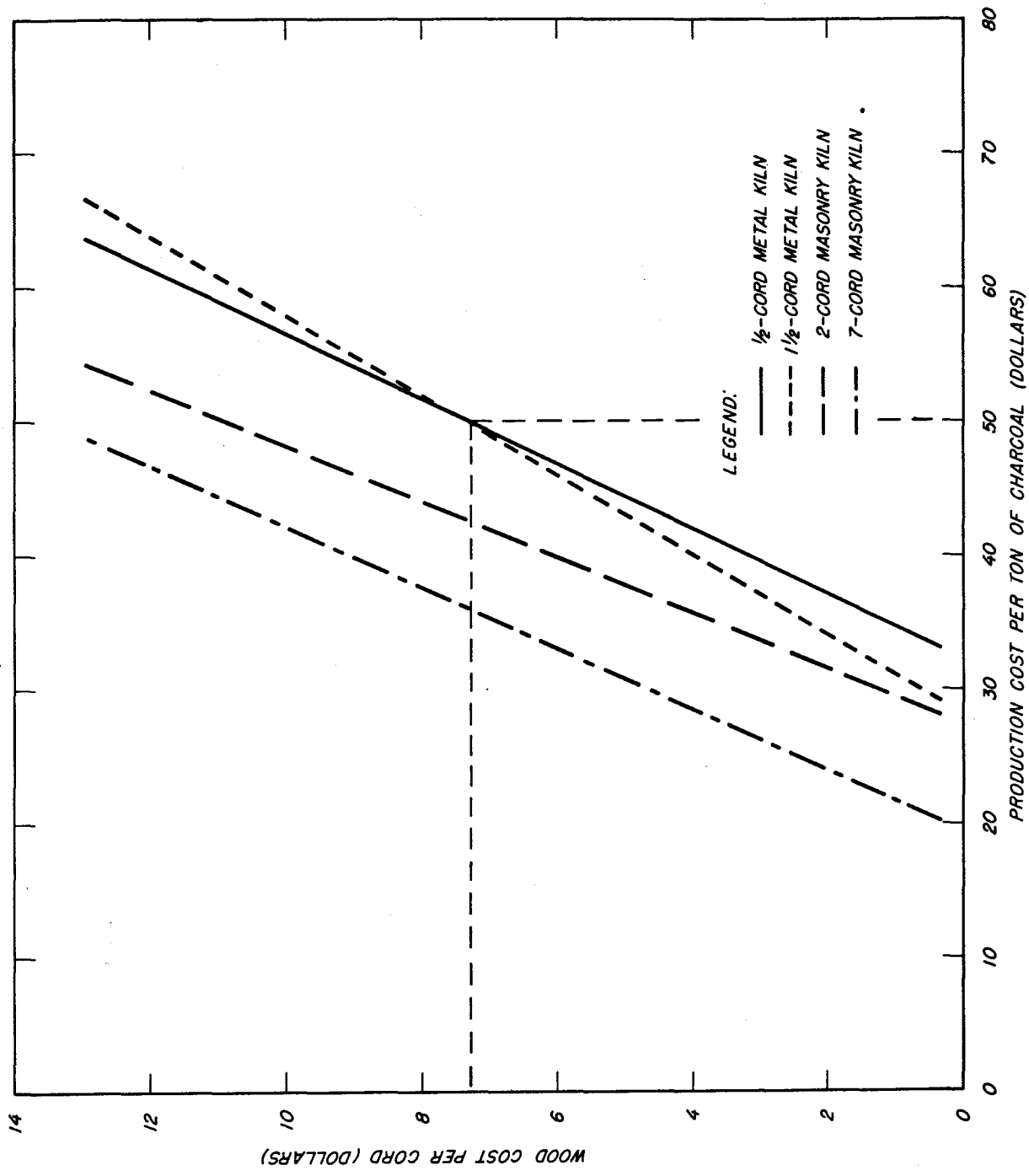

ZM 111 242

Figure 37. --Relationship of wood cost to charcoal production costs based on wood, labor, and depreciation charges.

## Stand Improvement Study

The cost of producing an average ton of charcoal in this combined experimental operation was \$27.44, exclusive of the cost of wood. This cost, added to that of the wood, represents the lowest market price that could be accepted if the operation were to break even. Such a price for the charcoal would cover the direct cost of labor, equipment, raw material, depreciation, and property taxes and yield a low rate of return on the invested capital. Some operators would be satisfied to break even, if their chief interest was in stand improvement and there was a lack of other markets for small roundwood. A study of direct production costs was therefore undertaken to determine the feasibility of charcoal production as a means of absorbing stand-improvement costs.

This study included the use of 154.5 cords of second-growth northern hardwoods for coaling obtained from a 30-acre improvement cutting. Another 129.9 cords, consisting of merchantable material with a stumpage value of \$472.72, was also cut from the same area. The cost of the wood for coaling delivered to kiln site was \$13.90 a cord. For the 14 runs conducted, each 2.52 cords of the seasoned material used produced an average of 1 ton of commercially acceptable charcoal.

In the production cost analysis, the break-even cost for a ton of charcoal produced was considered to be the sum of the charges met in each major step of the coaling process. An itemized summary of the kiln investment and operational costs, with labor at \$1.47 per man-hour, is shown in table 11.

Table 11.- Charcoal production cost per ton, excluding maintenance<sup>1</sup>

Item	cost	
	Per ton	Per cord
Kiln construction and depreciation	\$8.83	\$3.50
Loading	7.41	2.94
Door closure (laying blocks in opening):	3.60	1.43
Firing, control, and sealing	5.59	2.21
Kiln discharge and truck loading	2.01	.80
<b>Total</b>	<b>\$27.44</b>	<b>\$10.88</b>

<sup>1</sup>Kiln maintenance excluded because of lack of data. No major repair was required during the 14-run test period.



The production cost of \$10.88 a cord, together with the cost of wood at \$13.90 a cord, represents a total conversion cost of \$24.78 per cord of wood. Comparing this with \$21.80, or the amount obtained by sale of the bulk charcoal at an assumed price of \$55 a ton, shows a net loss of \$2.98 per cord. However, the stand improvement cut yielded 129.9 cords of merchantable stumpage along with the 154.5 cords of charcoal wood or generally unmerchantable material. The total cost for logging and kiln operation, as indicated in the accompanying cost summary, was \$3,828.51 as compared to a return of \$3,844.77, inclusive of \$472.72 for stumpage sales. The combined operation, then, provided a profit of \$16.26 or about \$0.54 per acre.

If the stand improvement had been done without coaling the nonmerchantable wood, the cost of felling and lopping it would have been \$6.50 a cord or \$1,004.25. The returns from the sale of the merchantable material would be the same, or \$472.72. As may be seen in the second itemized summary, the cost of the improvement work under these latter conditions would be \$531.53, or \$17.72 per acre. It can be concluded, therefore, that the operation of the kiln would enable the owner to break even on the stand improvement work when there is a market for the charcoal at \$55 a ton.

**Table 12. --Effect of charcoal kiln operations on the cost for timber stand improvement**

Item	Nonmerchantable wood used for coaling	Nonmerchantable wood not utilized
<b>costs</b>		
Logging	\$2,147.55	\$1,004.25
Charcoal manufacture	1,680.96	
<b>Total cost</b>	<b>3,828.51</b>	<b>1,004.25</b>
<b>Returns</b>		
Stumpage sales	472.72	472.72
Charcoal sales		
(at \$55 per ton)	3,372.05	
<b>Total returns</b>	<b>3,844.77</b>	<b>472.72</b>
<b>Net profit on timber stand</b>		
Improvement	16.26	-531.53
<b>Profit per acre</b>	<b>.54</b>	<b>-17.72</b>

The relationship between the selling price of bulk charcoal, labor cost, and maximum allowable wood cost established from the values developed in this study is indicated in figure 38. From this chart, the maximum wood cost allowable to break even can be estimated. For example, if labor cost is \$1.25 an hour and the top price for bulk charcoal is \$50 a ton at the kiln, the cost of wood must not be over \$10 a cord to break even. This can be shown on the chart by following the dashed line vertically from the \$1.25 point on the base line until it meets the selling price line of \$50 per ton, then continuing horizontally to the left to find the allowable break-even cost of wood, \$10 a cord.

If labor costs less than \$1 per hour, the chart may again be used by extending the diagonal line to meet a vertical line placed from a scaled point on the base line and then moving horizontally to the right to the maximum break-even cost of the wood. As another example, an assumed labor cost of 85 cents per hour and a charcoal selling price of \$55 a ton would indicate an allowable break-even wood cost of nearly \$14 a cord. This allowable wood cost may be also found from the equation for these regression lines, thus:

$$\text{wood cost} = 0.395 \times \text{selling price} - 5.008 \times \text{labor cost} - 3.485$$

or:

$$(0.395) (55) - (5.008) (0.85) - 3.485 = 21.73 - 4.257 - 3.485 = \$13.99$$

The maximum allowable break-even cost for the wood is thus \$13.99. The equation may be used likewise to determine any of the three variables when the other two are known. To obtain a profit, it is quite plain that wood must be available at something less than a break-even cost based on a given labor charge and charcoal selling price.

Useful information on kiln production economics has been developed to only limited extent. The results from the studies just outlined, while not wide in scope, are helpful in pointing up the value of economic background as an important asset in commercial operation. Both studies include patterns for direct information and, applied either wholly or in part, would suggest good opportunities for establishing a build-up of basic information essential for most favorable kiln production.

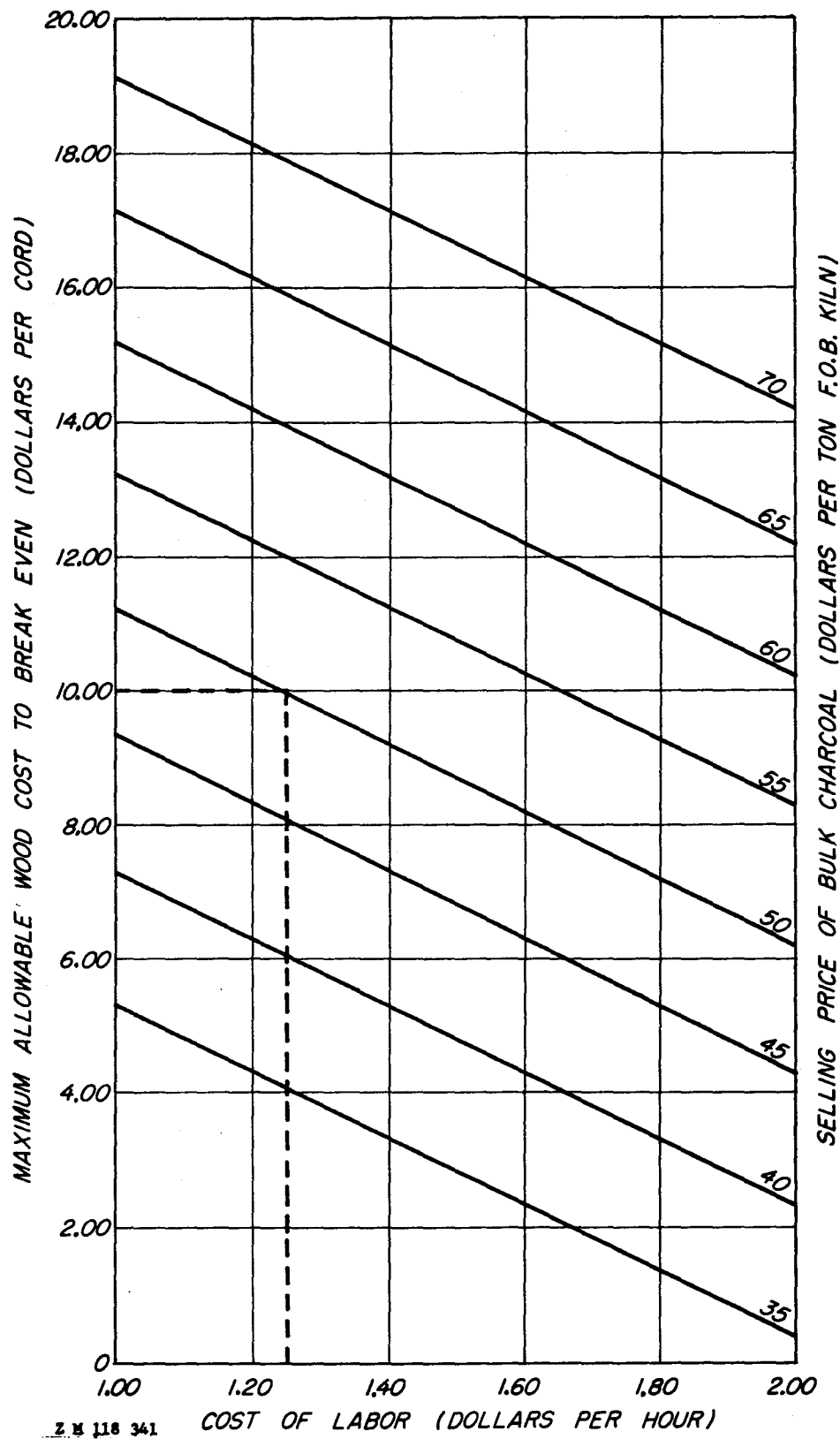

**Figure 38. - Relationship of charcoal selling price and labor cost to allowable wood (northern hardwoods) cost to break even. Cost of labor includes employer contributions for compensation, social security, and unemployment compensation.**

## A Method of Charcoal Analysis<sup>6</sup>

A practical standard method for the analysis of charcoal is desired by producers and laboratories that are concerned with the production and marketing of charcoal (51). Most of the present methods are based on American Society for Testing Materials standard methods for coal and coke (D-271-48; D-346-35). Various modifications of these methods, as well as other methods, are used. The method described here is specific for charcoal. The method employs equipment found in most laboratories, and is adapted to routine analyses of a large number of samples. It is designed to give accurate results for moisture, volatile matter, ash, and fixed carbon.

Since this new method differs from ASTM methods D-271-48 and D-346-35 in several details, data for duplicate determinations on 100 samples were analyzed statistically. The samples of charcoal were obtained at random from various sources in different parts of the country. The results were obtained by two analysts over a period of several months. Standard deviations of duplicates were: moisture, 0.06; volatile matter, 0.25; and ash, 0.07.

Four samples of charcoal were selected for repeated analysis. The selected samples were hardwood charcoals with volatile contents of 12, 15, 20, and 27 percent. Data for the repeated analyses on these four samples are shown in table 13. Since the stability of the values for volatiles in stored, ground charcoal is unknown, the data were collected over a period of approximately 2 months. The data indicate that, during this time interval, volatility values remained constant for samples stored in sealed containers at room temperature. The data also demonstrate that the accuracy and reproducibility of the method are acceptable for establishing the quality of charcoal and for determining the effects of variables in production.

The four ground samples (table 13) were submitted to two laboratories of large independent producers of charcoal for analysis by their methods. Results are shown in table 14. It can be seen that agreement is good.

In view of the data shown in tables 13, 14, and 15, the following procedure for the analysis of charcoal is outlined. By this procedure, 30 samples in duplicate (60 complete determinations) can be carried out by one analyst in 2 days.

---

<sup>6</sup>Prepared by the Forest Products Laboratory for consideration by ASTM Committee as a tentative ASTM Standard.

**Table 13.- Repeated charcoal analyses**

Date	Moisture		Volatile		Ash		Moisture		Volatile		Ash	
	Percent	Average	Percent	Average	Percent	Average	Percent	Average	Percent	Average	Percent	Average
	<u>Sample I</u>						<u>Sample II</u>					
1-16-58	1.83		12.53		4.42		1.85		15.67		2.88	
	1.83		11.45		4.38		1.88		15.35		2.81	
		1.83		11.99		4.40		1.86		15.51		2.84
1-20-58	1.92		11.52		4.36		1.92		15.29		2.79	
	1.87		11.94		4.44		1.91		15.55		2.76	
		1.90		11.73		4.40		1.92		15.42		2.78
1-27-58	1.71		12.72		4.51		1.84		15.62		2.82	
	1.74		11.47		4.49		1.81		15.71		2.86	
		1.73		12.10		4.50		1.82		15.66		2.84
2-3-58	1.84		12.84		4.48		1.95		15.57		2.92	
	1.83		11.41		4.49		1.96		15.66		2.87	
		1.84		12.13		4.49		1.96		15.62		2.90
2-10-58	1.88		11.80		4.47		1.93		15.18		2.97	
	1.91		11.15		4.44		1.92		14.94		2.93	
		1.90		11.48		4.46		1.92		15.06		2.95
2-17-58	1.84		11.36		4.47		1.95		15.30		2.80	
	1.85		11.48		4.39		1.91		15.66		2.81	
		1.85		11.42		4.43		1.93		15.48		2.80
2-24-58	1.59		12.44		4.30		1.66		15.68		2.83	
	1.56		11.69		4.30		1.63		15.56		2.76	
		1.58		12.07		4.30		1.64		15.62		2.80
3-27-58	1.84		12.19		4.41		1.87		15.67		2.86	
	1.82		11.91		4.50		1.88		15.16		3.12	
		1.83		12.05		4.46		1.88		15.42		2.99
Std. Dev.		.107		.288		.063		.099		.191		.077
	<u>Sample III</u>						<u>Sample IV</u>					
1-27-58							2.77		26.75		2.33	
							2.76		27.03		2.30	
								2.76		26.89		2.32
2-3-58	2.00		19.73		1.88		2.92		27.06		2.29	
	1.98		19.98		1.91		2.88		27.27		2.22	
		1.99		19.86		1.90		2.90		27.16		2.26
2-10-58	1.99		19.83		1.95		3.05		26.49		2.33	
	2.03		19.59		1.89		2.97		26.59		2.31	
		2.01		19.71		1.92		3.01		26.54		2.32
2-17-58	1.98		19.77		1.84		3.04		26.18		2.24	
	1.99		19.89		1.95		3.04		26.07		2.21	
		1.98		19.83		1.90		3.04		26.12		2.22
2-24-58	1.55		20.31		1.85		2.48		27.10		2.11	
	1.54		20.10		1.84		2.46		27.07		2.13	
		1.54		20.20		1.84		2.47		27.08		2.12
3-27-58	1.94		20.31		1.92		2.91		26.76		2.18	
	1.94		20.18		1.86		3.04		27.11		2.22	
		1.94		20.24		1.89		2.98		26.93		2.20
Std. Dev.		.197		.240		.027		.215		.391		.075

**Table 14.--Analysis of charcoals by three laboratories**

	Forest Products Laboratory	Independent laboratory A Analyst						Independent laboratory B <sup>1</sup>
		1	2	3	1	2	3	
	Percent	Percent	Percent	Percent	Percent	Percent	Percent	
SAMPLE NO. 1								
Moisture	1.82	1.7	1.7	1.7		2.4	1.3	
Volatile	11.99	11.7	10.9	11.1	11.4	11.2	10.8	
Ash	4.45		4.3				4.6	
Fixed carbon	83.56		84.8				84.9	
SAMPLE NO. II								
Moisture	1.89	1.4	1.5	1.5		2.3	1.4	
Volatile	15.55	15.7	14.9	15.0	15.7	15.7	14.9	
Ash	2.84		2.7				2.8	
Fixed carbon	81.61		82.4				82.2	
SAMPLE NO. III								
Moisture	1.99	1.8	1.8	1.8			1.6	
Volatile	19.86	20.1	19.1	20.0	19.8	19.9	20.3	
Ash	1.90		1.8				1.8	
Fixed carbon	78.24		79.1				77.9	
SAMPLE NO. IV								
Moisture	2.83	2.8	2.7	2.7			2.2	
Volatile	27.03	27.1	26.5	26.5	27.2	27.3	27.6	
Ash	2.29		2.2				2.5	
Fixed carbon	70.68		71.3				69.9	

<sup>1</sup>Data recalculated so that volatile, ash, and fixed carbon are also on the oven-dry basis.

Table 15.- Screen analysis of charcoal samples ground in Wiley mill

Screen size <sup>1</sup>	Sample number															Average of 15 samples
	I	II	III	IV	V	VI	VII	VIII	IX	X	XI	XII	XIII	XIV	XV	
Plus 20	0	0	0	0	0	0	0	0	0.8	0	0	0	0	0	0	0.05
20 x 40	18.2	16.9	12.6	12.0	11.4	13.5	13.2	12.6	12.2	11.0	15.4	15.9	16.1	17.1	17.9	14.40
40 x 60	15.8	16.2	22.0	13.6	24.4	16.9	21.4	21.0	21.1	18.7	19.9	17.6	18.6	17.0	16.8	18.73
60 x 80	6.4	6.9	8.6	7.5	8.4	7.2	7.7	8.9	2.9	7.2	6.8	7.1	6.6	6.4	5.8	6.96
80 x 100	2.3	2.1	1.7	2.5	6.7	4.4	5.5	6.1	4.9	1.6	3.3	3.5	1.6	2.6	2.1	3.40
Minus 100	57.3	57.9	55.1	64.4	49.1	58.0	52.2	51.4	58.1	61.5	54.6	55.9	57.1	56.9	57.4	56.46

<sup>1</sup>U.S. Standard Sieve.

<sup>2</sup>Percent of sample retained on the smaller screen.

## Procedure for the Analysis of Charcoal

### I. Sample Preparation

For the analysis to have value and meaning, a representative sample must be selected. This selection may be carried out according to ASTM methods for sampling of coal (D-271-48; D-346-35). Samples will normally be air-dry charcoal lumps or briquettes. Rain-soaked or wet samples should be spread out to air dry before they are analyzed. For determining the moisture content of the charcoal as received, the sample should be ground to pass a coarse screen such as No. 20 U.S. Standard Sieve, since heat generated by excessive grinding would cause loss of moisture. For the determination of volatile matter, a more finely ground sample is required. All of the selected sample should be ground; no part of the sample is to be rejected.

A Wiley mill, size No. 2 with a 1-millimeter screen, was used to give the screen analysis shown in table 15. Three hundred grams of charcoal were ground in less than 5 minutes. Longer grinding times resulting from the use of a finer screen or dull knives should be avoided because of the possibility of generating heat, which in turn causes a loss of volatile material. Excessive grinding will also produce a large amount of fine particles (smaller than 100 mesh, U. S. Standard Sieve). These fine particles may be swept out of the crucible during the rapid evolution of gases in the determination of volatile matter, and thus cause errors. Because over-size particles can result in low values for volatiles, particles larger than No. 20 U.S. Standard Sieve should be avoided. The ground samples should be stored in airtight containers such as screw-top bottles. The samples should be well mixed by shaking before they are weighed. "Jack stones" can be used to facilitate mixing.

### II. Steps in Analysis

Analyses are carried out in duplicate.

1. A muffle furnace that will control temperatures of  $750^{\circ} \pm 5^{\circ}$  C. and  $950^{\circ} \pm 5^{\circ}$  C. is required. Heat the muffle furnace to  $750^{\circ}$  C. and place previously ignited-porcelain crucibles (41 millimeters x 37 millimeters) and lids in furnace for 10 minutes.

2. The crucibles are cooled in desiccator for 1 hour.

3. Weigh crucibles and add an accurately weighed (to 1/10 milligram) sample of approximately 1 gram of charcoal.

---

<sup>7</sup>In practice, crucibles from previous determinations are used.



4. For moisture content, place samples in oven at 105° C., and dry for 2 hours.
5. Remove dried samples from oven and cool in desiccator for 1 hour and weigh. <sup>8</sup>
6. For the determination of volatiles, heat muffle furnace to 950° C.
7. The crucibles, with lids in place and containing the samples used for the moisture determination, are preheated as follows: With furnace door open, for 2 minutes on the outer ledge of the furnace (300° C.) and then 3 minutes on the edge of the furnace (500° C.). Individual nichrome wire baskets to hold the crucibles are convenient (fig. 39).
8. The samples are then moved to the rear of the furnace for 6 minutes with the muffle door closed. The samples are watched through a small peep-hole in the door of the furnace. If sparking occurs, results will be in error. If the sparking sample does not check the results of its nonsparking duplicate within ±0.5 percent, the analyses must be repeated.
9. The samples are removed and placed in a desiccator for 1 hour and weighed.
10. For ash determination, place the lids and the uncovered crucible containing the sample used for the volatile determination in the muffle furnace at 750° C. for 6 hours.
11. The crucibles with lids in place are cooled in a desiccator for 1 hour and weighed; Burning of the sample is repeated until successive 1 hour periods of heating result in a loss of less than 0.0005 gram.

12. Computations:

$$\text{A. Moisture percent} = \frac{\text{loss in weight} \times 100}{\text{weight of air-dry sample}}$$

Report results to first decimal place. Moisture values for duplicates should agree within 0.1 percent.

$$\text{B. Volatile percent} = \frac{\text{loss in weight} \times 100}{\text{weight of oven-dry sample}}$$

---

<sup>8</sup>The sample shall be considered oven-dry when the decrease in weight of consecutive weighings is 0.0005 gram or less. Successive drying periods shall not be less than 1 hour.

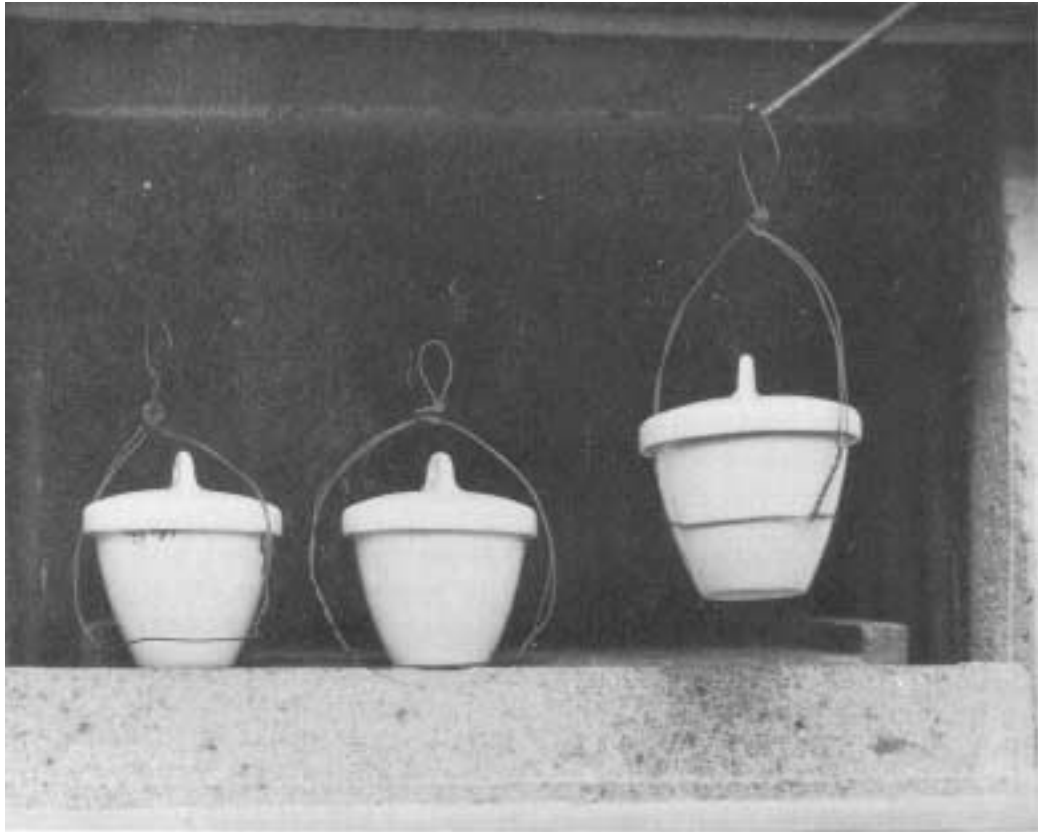

**Figure 39. - Nichrome wire baskets for handling covered crucibles.  
ZM 114 219**

**Ovendry weight = weight of air-dry sample minus moisture. Report results to first decimal place.**

**Volatile values for duplicates should agree within 0.5 percent.**

$$\text{C. Ash percent} = \frac{\text{weight residue} \times 100}{\text{weight of oven-dry sample}}$$

**Report results to first decimal place.**

**Ash values for duplicates should agree within 0.1 percent.**

**All results except moisture are reported on the oven-dry basis.**

### **Conclusions**

**The rapidly widening market for charcoal as recreational fuel is of interest to many seeking new business ventures or opportunities for investment of capital. A number of factors should be considered, however, before any action is undertaken.**

**A source of adequate supplies of low-cost raw material is of greatest importance. Operations based on wood costs much above \$9 a cord at kiln site, that is, competing with pulpwood operations, have little assurance of success. Sources of wood residue, such as slabs, edgings, cull bolts and logs, veneer cores, bark, and sawdust, if available at relatively low price and with little added cost for transportation, provide an exceptionally good situation. Between these extremes of raw material at high and low prices, there is a condition where good forest management indicates the removal of low-grade or otherwise unmarketable wood for stand improvement. Thus, with charcoal production, part of the wood costs can be charged against forest management.**

**With suitable coaling equipment, the advantage of one form of raw material over another is chiefly one of cost. Assuming wood costs to be favorable, a decision regarding the type and size of equipment best fitted to the kind and quantity of raw material is required. The several types of small, upright retorts commercially available apparently can efficiently convert forest and mill residues with comparatively low labor requirements and initial investment (71, 78). For mill fines, wood chips, and similar material, rather high-cost equipment for continuous carbonization would be required (27, 52). Briquetting of the carbon fines produced would necessitate substantial investment.**

Using cordwood, mill slabs, trimmings, or short-length roundwood and slab wood, coaling could be carried out in any of several types and sizes of metal, masonry block, brick, and reinforced concrete structures. The metal units have small capacity but are readily portable and frequently adapted to operations where it is desirable to move kilns often rather than transport the wood. These kilns are simple to operate and require little maintenance to keep them operable. They are available at a price of about \$350 for the 1/2-cord size. A chief disadvantage in their use is the lower yields of charcoal obtained.

Masonry-block kilns in sizes from 2 to about 10 cords are commonly employed. Construction is fairly simple and carried out at costs generally from \$100 to about \$200 per cord of capacity, depending upon whether construction is undertaken by the operator or by contract. This type of structure is susceptible to cracking and must be properly constructed and reinforced. Such structures require continuous maintenance. Coaling can be readily conducted in these kilns and, when equipped with inexpensive temperature-indicating instruments (61, 62), will produce consistently high yields of good-quality charcoal.

Rectangular or beehive-type kilns of brick construction and others of reinforced concrete have capacities of 5 to about 100 cords. The investment per cord of capacity is estimated to be between \$100 and \$150 for these kinds of construction. The larger sizes require several weeks for each cycle of operation. The yields per cord are somewhat lower than from the smaller, masonry-block units. Because of the large volume of materials handled, these larger kilns are well adapted to mechanization. Other types of kilns, of course, are likewise adaptable where production is comparatively high.

As may be seen from the foregoing, the choice of production facilities is not subject to definite prescription but must be considered in the light of many factors associated with each operation.

The problem of marketing charcoal must be recognized and seriously considered. With the present strong market preference for briquettes, the solution is not difficult for any operator who can sell his product to a briquetting plant at wholesale prices. To do this at a profit, however, requires that production costs be at a minimum. An alternative procedure would be to install a briquetting and packaging plant and sell the product at the higher retail prices. This would necessitate a sales organization and sustained contracts to assure continuous operation.

Many small producers package the lump charcoal and sell it wholesale to retail outlets. This practice provides greater returns than selling bulk amounts in spite of the added costs for packaging, transportation, and sales.

## Appendix

### Partial List of Suppliers<sup>9</sup>

#### Microammeter (Approximate cost \$20.00)

**Allied Radio**  
**100 N. Western Ave.**  
**Chicago 80, Ill.**

**Catalog No. 160**  
**Stock No. 67F444**  
**D. C. microammeter, range 0 to 25**  
**2200 ohms internal resistance**

**Burstein-Applebee Co.**  
**1012-14 McGee St.**  
**Kansas City, Mo.**

**Catalog No. 571**  
**Stock No. 29A1338**  
**D. C. microammeter, range 0 to 25**  
**2200 ohms internal resistance**

**Newark Electric Co.**  
**223 W. Madison St.**  
**Chicago 6, Ill.**

**D. C. microammeter, model 29**  
**No. 55F175, range 0 to 25**  
**2200 ohms internal resistance**

#### Thermocouple wire (Approximate cost \$0.30 per foot)

#### Extension wire (Approximate cost \$3.00 per 100 feet)

**Most of the suppliers have State or regional offices which cannot be listed here. The following are the home office addresses:**

**The Bristol Co.**  
**Waterbury 91, Conn.**

**The Lewis Engineering Co.**  
**Naugatuck, Conn.**

**Thermo Electric Co., Inc.**  
**Saddle River Township**  
**Rochelle Park Post Office, N. J.**

**Minneapolis -Honeywell Regulator Co.**  
**Wayne and Windrim Ave.**  
**Philadelphia 44, Pa.**

---

<sup>9</sup>The inclusion or exclusion of names in this list does not imply endorsement of any company or products by the Forest Service.

**Tentative list of companies designing, fabricating, and installing charcoal briquetting equipment:**

**Komarek-Greaves Company**  
2941 Mozart St.  
Chicago, Ill.

**Webb Corporation**  
Webb City, Mo.

**F. J. Stokes Machinery Company**  
5930 Tabor Road  
Philadelphia, Pa.

**Aeroglide Corp.**  
Raleigh, N. C.

**Vulcan Iron Works**  
Wilkes-Barre, Pa.

**Tentative list of companies designing, fabricating, and installing byproduct-recovery plant equipment:**

**Badger Manufacturing Company**  
230 Bent St.  
Cambridge, Mass.

**Chemical Construction Corporation**  
New York City, N. Y.

**Posey Iron Works**  
Lancaster, Pa.

#### **Charcoal Moisture Tester**

This instrument, manufactured in England, is called the "Speedy Moisture Tester." Sale is made through the Alpha-Lox Co., Inc., 60 E. 42nd St., New York 17, N.Y. The quoted price from the only known source of supply is \$160.

#### **Requirements for Temperature-Indicating Meter**

The temperature-indicating instrument should have a direct current microammeter range of 0 to 25 microamperes and resistance of 2,200 ohms. This type of meter may be purchased for a nominal cost from supply sources.

The meter, as procured, requires a scale for directly reading kiln temperatures in degrees Fahrenheit. A scale which may be used for this purpose can be cut from figure 40. The cut-out scale may be easily applied by first

carefully removing the scale plate from the meter and then rubber-cementing it onto the scale plate. It should be kept in mind that the scale furnished with the meter be of the same size and shape as the scale shown in figure 40. The kiln temperature scale should be redesigned if that in the meter varies in design and type from the scale illustrated in figure 40.

### Wire Requirements

The wiring necessary for temperature indication on the kiln-temperature meter requires that two different types of wire be used. The wire for placement within the kiln is termed thermocouple wire and that for use on the outside of the kiln connecting the thermocouples to the meter is the extension wire. Both the thermocouple and extension leads have separated wires of different metals, one of which, in the system herein described, is iron and the other constantan and commonly referred to as iron-constantan wire.

Thermocouple wire. - When ordering wire from the supplier, the following information should be furnished: Iron-constantan parallel paired thermocouple wire; 16- or 18-gage, solid, asbestos insulated, stainless-steel mesh overbraid.

Extension wire. -The following information with the number of feet desired should be furnished the supplier: Weatherproof-type, iron-constantan parallel paired extension wire; 24 gage, polyvinyl insulation.

This wire may be also of heavier gage (22 to 16) with other suitable weatherproof insulation.

The thermocouple wire for use within the kiln must be abrasion resistant (preferably stainless-steel mesh overbraid), and the insulation should be of asbestos to withstand the high kiln temperatures.

### Wiring

Meter. - A 3- to 4-inch length of the constantan strand of the wire is attached to the positive (plus) post of the meter, as shown in figure 41. The iron strand of the paired extension wire is then twisted and soldered to this short length of constantan strand, forming a reference junction later described. The constantan strand of the paired extension wire is attached to the negative (minus) post of the meter.

The meter is a precision instrument, and for proper use should be mounted in a box, as shown in figure 27. Binding posts, clips, or jacks can be

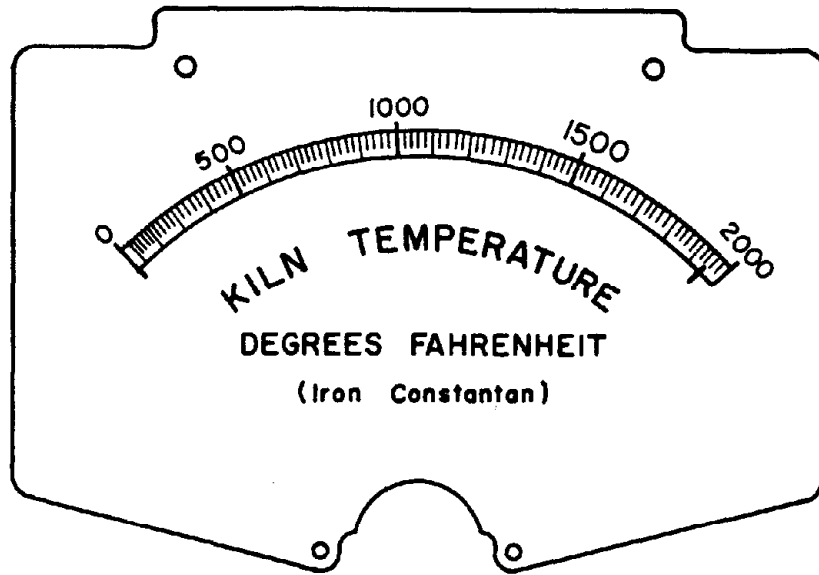
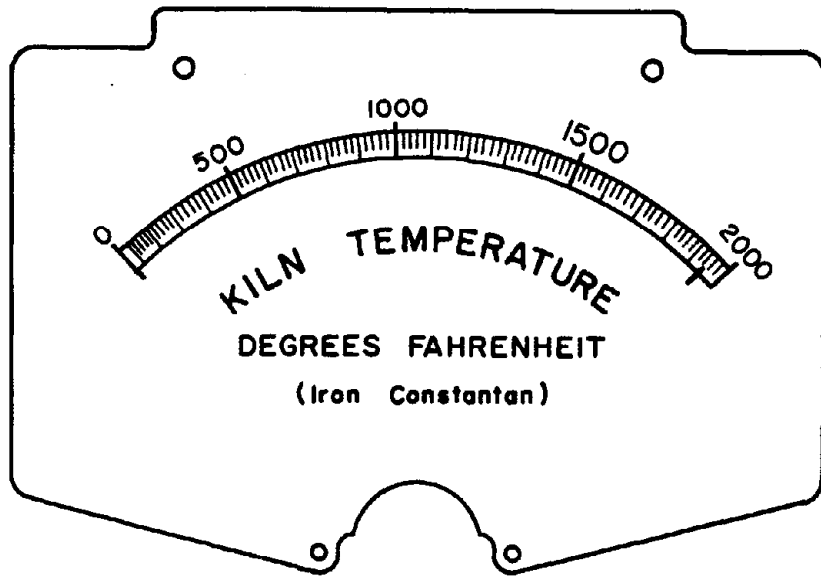

Z M 118 282

**Figure 40. - -Cutout temperature scales for microammeter.**



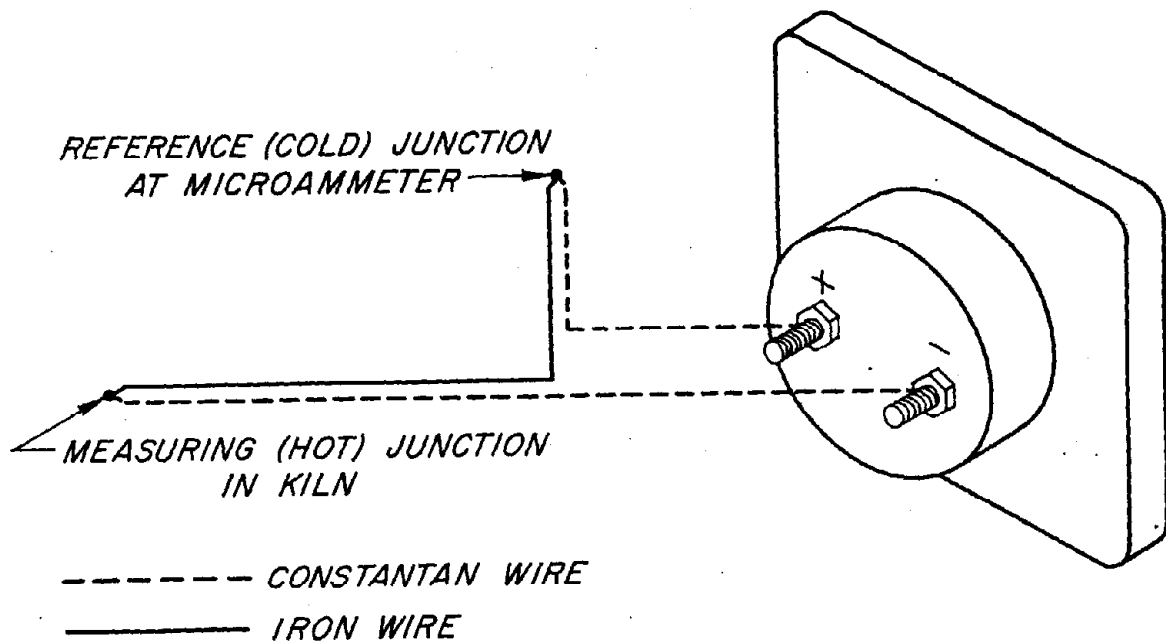

Z M 118 342

**Figure 41. - - Procedure for connecting thermocouple wires.  
to microammeter.**

attached to the back of the box for easy connection to the extension wire leading to the thermocouples. An electrician or local radio repairman can make a simple switching device to service a number of thermocouples without moving the meter, for connection to various thermocouple leads.

**Thermocouples.** - Many types and kinds of thermocouples ready for use are available for purchase. Using the thermocouple wire previously described, an equally suitable thermocouple can be made quite readily by the kiln operator. This is done by stripping the insulation for about 1 inch from the ends of the paired wires, then firmly twisting the wires together, and finally fusing the wire tips by welding (fig. 28).

Three or preferably five thermocouples can be used for satisfactory control of temperature in masonry-block kilns of 2- to 10-cord capacity. The proper placement of such limited numbers of thermocouples is important, however, and, as indicated in figure 28, good locations are along the lengthwise centerline of the kiln and within 4 inches of the ceiling. Thermocouple No. 1 is placed just above and behind the forward end of the kiln charge, No. 2 at ceiling center, and No. 3 is put 1 to 2 feet from the rear wall. A fourth thermocouple is dropped through the same ceiling opening as No. 2, but hangs about halfway into the kiln. Thermocouple No. 5 is hung through the ceiling opening for No. 3 and dropped to about 2 feet from the floor.

Should only three thermocouples be used, suitable control is possible in the placement of a series as indicated for Nos. 1, 2, and 3 in figure 28 or in the series showing Nos. 1, 4, and 5. When the thermocouples have been securely placed, the extension wires should be attached as shown in figure 41.

#### **Meter Use and Care**

The meter should be handled carefully at all times if it is to perform properly with minimum repair or replacement. When there is no meter connection to the thermocouple, the indicating needle should be on the zero mark of the meter scale. If not, the needle may be adjusted to zero position by turning the screwhead on the face of the meter.

The meter indicates the difference between the temperature at the reference junction (air temperature) and that of the kiln thermocouple. The meter scale has been calibrated to give true readings at an air temperature (reference junction) of 75° F. A different air temperature will admit some error in indicated temperatures, but is of little importance in average kiln operation.

## Wire Use and Care

The steel overbraid sheathing around the thermocouple wire does not provide protection against moisture. It is necessary, therefore, that the portion extending beyond the outside of the kiln be protected from the weather. Wet thermocouple wire may develop "shorts" that cause the meter needle to swing off the high-temperature side of the scale or remain on the zero line.

Thermocouple wire, particularly the portion extending into the kiln charge, is subject to stretch and wear and may eventually break. Additional wire should be kept on hand for replacements.

The weatherproof insulation on the extension wire is harmed by heat conditions above 220° F. The wire should not touch hot surfaces or be placed in areas where the temperature is excessively high. Insulation damaged by heat may cause shorting of the paired extension wire. It is good practice to extend the thermocouple wire from the cooling chamber and through the ceiling for sufficient length so that the attached extension wire may be placed above and free of the ceiling structure and insulation.

## LITERATURE CITED

1. **Anonymous**  
1950. **Building Concrete Farm Structures.** Portland Cement Assoc., Chicago, Ill.
2. \_\_\_\_\_  
1947. **Facts About Concrete Masonry.** AIA File No. 10-C National Concrete Masonry Assoc., Chicago, Ill.
3. \_\_\_\_\_  
1952. **Charcoal Production and Uses.** Northeastern Wood Utilization Council, Inc. Bull. 37. New Haven, Conn.
4. \_\_\_\_\_  
1957. **Charcoal Production in the United States, 1955-56.** U.S. Dept. of Agric., Forest Service, Div. Forest Economics Research.
5. \_\_\_\_\_  
1949. **Edition, with Cumulative Pocket Supplement as of Jan. 1, 1956,** Code of Federal Regulations, Title 49 Transportation.

6. **Anonymous**  
1957. **Production of Charcoal in a Masonry Block Kiln--Structure and Operation. Forest Service, U.S. Dept. of Agric. processed Report No. 2084.**
  
7. \_\_\_\_\_  
1950. **Charcoal Production and Marketing in Alabama. Alabama Extension Service, Alabama Polytechnic Institute. Auburn.**
  
8. \_\_\_\_\_  
1957. **Charcoal Production in the Central States. Central States Forest Experiment Station Note No. 109. Columbus, Ohio.**
  
9. **Baldwin, H. I.**  
1949. **Yields and Costs of Charcoal Making. Fox Forest Note No. 43. Concord, N. H.**
  
10. \_\_\_\_\_  
1952. **Charcoal Production in Steel Drums. Northeastern Wood Utilization Council Bull. 37. New Haven, Conn.**
  
11. \_\_\_\_\_  
1958. **The New Hampshire Charcoal Kiln. New Hampshire Forestry and Recreation Commission Bull. No. 11. Concord.**
  
12. \_\_\_\_\_, and **Weld, E. A.**  
1941. **Charcoal Making in New Hampshire. Fox Forest Note No. 31, Concord.**
  
13. **Beazley, R.**  
1958. **Charcoal Marketing in the United States, Description and Analysis. Northeastern Logger 6(8): 34-37, 46, 53.**
  
14. \_\_\_\_\_  
1958. **Consumer Preference Testing. Northeastern Logger 6(8): 38.**
  
15. **Beglinger, E.**  
1952. **Charcoal Production. U.S. Forest Products Laboratory Report R1666-11 (Rev.).**
  
16. \_\_\_\_\_  
1957. **Charcoal Production in Kilns. Forest Prod. Jour. 7(11): 399-403.**
  
17. \_\_\_\_\_  
1958. **Distillation of Resinous Wood. U.S. Forest Products Laboratory Report No. 496 (Rev.).**

18. **Beglinger, E.**  
1958. **Charcoal Production Development- -Double Wall, Masonry Block and Other Type Kilns. Northeastern Logger 6(7): 26-27.**
19. \_\_\_\_\_  
1957. **Growing Charcoal Demand Means More Utilization Profits, Part I - Wood and Wood Products 62(12): 32-35.**
20. \_\_\_\_\_  
1958. **Use of Small Kilns Expanding Recreational Charcoal Output. Part 2 - Wood and Wood Products 63(1): 36, 64, 65.**
21. \_\_\_\_\_  
1956. **Hardwood Distillation Industry. U.S. Forest Products Laboratory Report No. 738 (Rev.).**
22. \_\_\_\_\_, and **Locke, E. G.**  
1957. **Charcoal--Its Manufacture and Use. Economic Botany 11(2): 160-173.**
23. **Bergstrom, Hilding.**  
1940. **Charcoal Making in Kilns and Chimney Kilns. Kolningslaboratoriets, Stockholm, Sweden.**
24. **Bolt, C. E., and Arbogast, Carl, Jr.**  
1960. **Charcoal Kiln Operation for Improved Timber Stands, Forest Prod. Jour. 10(1).**
25. **Chapman, H. H., and Meyer, W. H.**  
1949. **Forest Mensuration. 522 pp., illus., New York, Toronto, London.**
26. **Childs, Montgomery R.**  
1957. **Charcoal Production. Texas Forest Service Circular No. 57. Lufkin.**
27. **Dargan, E. E., and Smith, W. R.**  
1959. **Progress in Charcoal Production--Continuous Residue Carbonization. Forest Prod. Jour. 9(11): 395-397.**
28. **Grothe, C. H., Jr.**  
1954. **Using Small Hardwoods in Charcoal Production. Northeastern Logger 2(8): 24.**

29. **Grothe, C. L.**  
1958. **Experience Reports - Cinder Block Kilns. Northeastern  
Logger 6(8): 33.**
30. **Haigh, P. D.**  
1958. **Equipment and Costs for Profitable Charcoal Briquetting.  
Forest Prod. Jour. 8(10): 66-68A.**
31. \_\_\_\_\_  
1958. **Briquetting of Charcoal. Northeastern Logger 6(8): 33.**
32. **Hair, D.**  
1958. **Results of National Survey of Charcoal Production 1955-56.  
Northeastern Logger 6(7): 20-21, 44-45, 48.**
33. **Hampf, F. E.**  
1958. **Production and Sale of Charcoal in the Northeast. Northeastern  
Logger 6(7): 22-23, 37, 49.**
34. **Hawley, L. F.**  
1923. **Wood Distillation. The Chemical Catalog Co., Inc.**
35. **Hicock, H. W., and Olson, A. R.**  
1948. **The Connecticut Charcoal Kiln. Connecticut Agric. Experiment  
Station Bull. 519. New Haven.**
36. \_\_\_\_\_  
1941. **A Portable Charcoal Kiln. Connecticut Agric. Experiment  
Station Bull. 448. New Haven.**
37. \_\_\_\_\_, and **Callward, F. M.**  
1951. **The Connecticut Charcoal Kiln. Connecticut Agric. Experiment  
Station Bull. 431. New Haven.**
38. **Jarvis, J. Pitts**  
1960. **The Wood Charcoal Industry in the State of Missouri. Engineering  
Station Bull. 48. Columbia.**
39. **Jenner, R. W.**  
1958. **Cliffs-Dow Chemical Co. Northeastern Logger 6(8): 28-29,  
48-49, 52.**
40. **Keil, Alvin R.**  
1958. **Marketing of Charcoal. Northeastern Logger 6(8): 38.**

41. **Keil, Alvin R.**  
1960. Use of Mill Residues for Charcoal. *The Northeastern Logger* 8(9): 10.
42. **Kotok, E. S.**  
1955. The Production of Charcoal From Arizona Mesquite. *Rocky Mountain Res. Note No. 15.* Fort Collins, Colo.
43. **Lambiotte, Auguste.**  
1942. Process of Continuous Carbonization of Cellulosic Materials. U.S. Patent No. 2,289,917.
44. **Lane, P. H.**  
1957. Design of a Cinder-Concrete Block Charcoal Kiln. *Lake States Forest Experiment Station Tech. Note No. 494.* St. Paul, Minn.
45. \_\_\_\_\_  
1960. Wood Carbonization in Kilns. *Forest Prod. Jour.* 10(7): 344-348.
46. \_\_\_\_\_, and **Boldt, C. E.**  
1957. The Charcoal Research Program of The Lake States Forest Experiment Station. *Timber Producers Bull.* 13(5): 16.
47. \_\_\_\_\_, and **Sprenger, G. E.**  
1956. Design of an Experimental Charcoal Kiln. *Lake States Forest Experiment Station Tech. Note No. 471.* St. Paul, Minn.
48. **Locke, E. G., and Saeman, J. F.**  
1945. Wood Carbonization Industry in Germany. *F.I.A.T. Report No. 444.* Joint Intelligence Objectives Agency.
49. **May, Richard H.**  
1957. Wood Charcoal in California. *California Forest and Range Experiment Station Forest Survey Release No. 28.* Berkeley.
50. **McBride, R. S.**  
1932. A Survey of Hardwood Distillation in the United States. *Chem. and Met. Eng.* 39(10): 11, 12.
51. **Moore, W. E., and Beglinger, E.**  
1961. A Method of Charcoal Analysis. *Forest Prod. Jour.* 11(1).
52. **Nelson, W. G.**  
1930. Wastewood Utilization by the Badger-Stafford Process, *Ind. and Eng. Chem.* 22: 4.

53. **Olson, A. R.**  
1959. **A Smoke Burner for Charcoal Kilns. Northeastern Logger**  
7(7): 22.
54. \_\_\_\_\_  
1941. **A Portable Charcoal Kiln. Connecticut Agric. Experiment**  
**Station Bull. 448. New Haven.**
55. \_\_\_\_\_, and **Hicock, H. W.**  
1946. **A Charcoal Kiln Made of Cinder Concrete Blocks. Connecticut**  
**Agric. Experiment Station Bull. 494. New Haven.**
56. **Othmer, D. F.**  
1952. **Beehive Kiln Operation. Northeastern Wood Utilization Council**  
**Bull. 37. New Haven, Conn.**
57. **Pakula, A. C.**  
1957. **The Domestic Market for Charcoal in Oklahoma. Oklahoma A**  
**and M College Bull. No. B-495. Stillwater.**
58. **Pepper, H.**  
1958. **Marketing of Lumps vs. Briquettes. Northeastern Logger**  
6(8): 38.
59. **Perry, J. H.**  
1950. **Chemical Engineers Handbook. Ed. 3. McGraw-Hill Book**  
**Company, Inc. New York, N. Y.**
- 60 **Peter, Ralph**  
1957. **This Business of Charcoaling. Forest Farmer 16(8): 10.**
61. \_\_\_\_\_  
1958. **Charcoal Kiln Temperature Control. Northeastern Logger**  
6(7): 28-29, 46.
- \_\_\_\_\_   
1956. **An Inexpensive Method for Measuring Charcoal Kiln Temperatures.**  
**Southeastern Forest Experiment Station Paper No. 73.**  
**Asheville, N. C.**
63. **Pritchard, W. M.**  
1960. **A Simplified Charcoal Retort for Batch Operation. Forest Prod.**  
**Jour. 10(12): 640-641.**
64. **Reichert, Theophil.**  
1939. **Process for the Carbonization of Organic Cellulosic Materials**  
**of Vegetable Origin. U.S. Patent No. 2,160,341.**



- 65. Reichert, Theophil.**  
**1940. Process for the Carbonization of Wood and Similar Materials.**  
**U.S. Patent No. 2,202,231.**
- 66. Rieck, H. G., Jr., Locke, E. G., and Tower, Eugene.**  
**1944-45. Charcoal-Industrial Fuel From Controlled Pyrolysis of**  
**Sawmill Wood Waste. Timberman 46(2): 4,5.**
- 67. Risi, J.**  
**1958. Production of Charcoal in Brick Beehive Kilns. Northeastern**  
**Logger 6(7): 24-25, 36, 38.**
- 68. Shelton, Bill R., and Bradley, J. R.**  
**1955-56. The Marketing and Production of Charcoal in Texas. Texas**  
**Engineering Experiment Station Research Report No. 58.**  
**College Station.**
- 69. Simmons, F. C.**  
**1958. Cinder Block Kiln Operation. Northeastern Logger 6(8): 33.**
- 70. \_\_\_\_\_**  
**1957. Guides to Manufacturing and Marketing Charcoal in the North-**  
**eastern States. Northeastern Forest Experiment Station**  
**Paper No. 95. Upper Darby, Pa.**
- 71. \_\_\_\_\_**  
**1960. Revival in the Charcoal Industry. New York State Conserva-**  
**tionist. April-May.**
- 72. Skok, R. A., and Beazley, R. I.**  
**1955. A Review of the Charcoal Production and Marketing Situations**  
**in the U.S. With Reference to Minnesota. School of Forestry**  
**Mimeographed Report, University of Minnesota.**
- 73. Smith, B. D.**  
**1957. Today's Charcoal Briquetting Operations. Proceedings Inter-**  
**national Briquetting Assoc., Information Circular No. 9.**
- 74. Stillman, A. L.**  
**1923. Briquetting, Chemical Publishing Company, Easton, Pa.**
- 75. Troxell, H. E., and Barney, C. W.**  
**1956. The Colorado Experimental Charcoal Kiln. School of Forestry**  
**Research Note No. 3, Colorado A and M College,**  
**Fort Collins.**

76. Troxell, H. E., and Campbell, D. I.  
1956. Time-Temperature Study in Small Charcoal Kiln. School of Forestry Research Note No. 4, Colorado A and M College, Fort Collins.
77. Tryon, H. H.  
1933. A Portable Charcoal Kiln. The Black Rock Forest Bull. No. 4. Cornwall-on-the-Hudson, New York, N. Y.
78. United Nations.  
1960. Three New Charcoal Retorts, Equipment Section Paper No. E24.60. Rome, Italy.
79. U.S. Forest Products Laboratory.  
1955. Wood Handbook No. 72. Madison, Wis.
80. U.S. Forest Service.  
How to Make Charcoal on the Farm. State and Private Forestry Report No. 436.
81. Van Geuns, R. E.  
1958. Charcoal Briquettes --A Manufacturing Opportunity in Georgia. Project B-140-2, Georgia Institute of Technology, Engineering Experiment Station, Atlanta.
82. Ward, James C.  
1959. Air Seasoning of Wood Reduces Charcoal Production Time. Lake States Forest Experiment Station Tech. Note No. 566. St. Paul 1, Minn.
83. \_\_\_\_\_, and Lane, P. H.  
1960. Water Sprays Will Shorten Charcoal Cooling Time. Lake States Forest Experiment Station Tech. Note No. 582. St. Paul, Minn.
84. \_\_\_\_\_  
1959. The Effect of Time and Carbonizing Temperatures on the Quality of Charcoal from a Cinder-Concrete Block Kiln. Lake States Forest Experiment Station Tech. Note No. 557. St. Paul 1, Minn.
85. Warner, J. R.  
1957. How Large is the Charcoal Market? Lake States Forest Experiment Station Tech. Note No. 477. St. Paul 1, Minn.

- 86. Warner, J. R., and Lord, W. B.**  
**1957. The Market for Domestic Charcoal in Wisconsin. Lake States Forest Experiment Station Paper No. 46, St. Paul 1, Minn.**
- 87. \_\_\_\_\_, and Essex, B. L.**  
**1960. Trends in the Wisconsin Charcoal Market. Lake States Forest Experiment Station Paper No. 80. St. Paul 1, Minn.**
- 88. Webber, L. E.**  
**1955. Beech for Fuel and Charcoal. Beech Utilization Series No. 12. Northeastern Technical Comm. Coop. Northeastern Forest Experiment Station. Upper Darby, Pa.**
- 89. Witherow, B. M.**  
**1956. Information About the Charcoal Industry in the Southeast. Southeastern Forest Experiment Station. Asheville, N. C.**
- 90. \_\_\_\_\_, and Smith, W. R.**  
**1957. Cost of Operation for Three Types of Charcoal Kilns. Southeastern Forest Experiment Station Paper No. 79. Asheville, N.C.**
- 91. Wyman, Lenthall.**  
**Charcoaling--An Outlet for Poor-Quality Trees. North Carolina State College Agricultural Extension Service.**
- 92. Yoho, J. G., and Robinson, V. L.**  
**1956. Retail Marketing of Charcoal in Iowa. Iowa Agricultural Experiment Station Paper No. G-3063. Ames.**

**Forest Utilization Research Division representatives can be reached at the following Forest Service Experiment Stations:**

**Pacific Southwest Forest and Range  
Experiment Station  
P. O. Box 245  
Berkeley 1, California**

**Central States Forest Experiment Station  
111 Old Federal Building  
Columbus 15, Ohio**

**Lake States Forest Experiment Station  
University of Minnesota  
Green Hall, St. Paul Campus  
St. Paul 1, Minnesota**

**Intermountain Forest and Range  
Experiment Station  
Forest Service Building  
25th Street and Adams Avenue  
Ogden, Utah**

**Northeastern Forest Experiment Station  
102 Motors Avenue  
Upper Darby, Pennsylvania**

**Pacific Northwest Forest and Range  
Experiment Station  
809 N.E. Sixth Avenue  
P. O. Box 4059  
Portland 8, Oregon**

**Rocky Mountain Forest and Range  
Experiment Station  
Colorado State University  
221 Forestry Building  
Fort Collins, Colorado**

**Southeastern Forest and Range  
Experiment Station  
225 Federal Building  
P. O. Box 2570  
Asheville, North Carolina**

**Southern Forest and Range Experiment  
Station  
704 Lowich Building  
2026 St. Charles Avenue  
New Orleans 13, Louisiana**

