



AN EVALUATION OF THE TECHNICAL FEASIBILITY  
OF PHOTOCATALYTIC OXIDATION AND PHASE  
TRANSFER CATALYSIS FOR DESTRUCTION  
OF CONTAMINANTS FROM WATER

John C. Crittenden, David W. Hand, Yin Zhang  
Michael E. Mullins

Michigan Technological University  
1400 Townsend Drive  
Houghton MI 49931

ENVIRONICS DIRECTORATE  
139 Barnes Drive, Suite 2  
Tyndall AFB FL 32403-5323

June 1996

Final Technical Report for Period May 1990 - December 1994

Approved for public release; distribution unlimited.

19961125 074

AIR FORCE MATERIEL COMMAND  
TYNDALL AIR FORCE BASE, FLORIDA 32403-5323

ARMSTRONG

LABORATORY

||

## NOTICES

This report was prepared as an account of work sponsored by an agency of the United States Government. Neither the United States Government nor any agency thereof, nor any employees make any warranty, expressed or implied, or assume any legal liability or responsibility for the accuracy, completeness, or usefulness or any privately owned rights. Reference herein to any specific commercial process, or service by trade name, trademark, manufacturer, or otherwise does not necessarily constitute or imply its endorsement, recommendation, or favoring by the United States Government or any agency, contractor, or subcontractor thereof. The views and opinions of the authors expressed herein do not necessarily state or reflect those of the United States Government or any agency, contractor, or subcontractor thereof.

When Government drawings, specifications, or other data are used for any purpose other than in connection with a definitely Government-related procurement, the United States Government incurs no responsibility or any obligations, whatsoever. The fact that the Government may have formulated or in any way supplies the said drawings, specifications, or other data, is not to be regarded by implication, or otherwise in any manner construed, as licensing the holder or any person or corporation; or as conveying any rights or permission to manufacture, use or sell any patented invention that may in any way be related thereto.

This technical report has been reviewed by the Public Affairs Office (PA) and is releasable to the National Technical Information Service, where it will be available to the general public, including foreign nationals.

This report has been reviewed and is approved for publication.

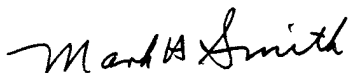

MARK H. SMITH, Major, USAF, BSC  
Project Officer



MARK H. SMITH, Major, USAF, BSC  
Chief, Site Remediation Division

# DRAFT SF 298

<b>1. Report Date (dd-mm-yy)</b> June 1996		<b>2. Report Type</b> Final		<b>3. Dates covered (from... to )</b> 1 May 1990 to 31 December 1994	
<b>4. Title &amp; subtitle</b> An Evaluation of the Technical Feasibility of Photocatalytic Oxidation and Phase Transfer Catalysis for Destruction of Contaminants from Water			<b>5a. Contract or Grant #</b> F08635-90-C-0063		
			<b>5b. Program Element #</b> 62202F		
<b>6. Author(s)</b> John C. Crittenden, David W. Hand, Yin Zhang, Michael E. Mullins, et al.			<b>5c. Project #</b> 1900		
			<b>5d. Task #</b>		
			<b>5e. Work Unit #</b> 7068		
<b>7. Performing Organization Name &amp; Address</b> Michigan Technological University 1400 Townsend Drive Houghton, MI 49931				<b>8. Performing Organization Report #</b>	
<b>9. Sponsoring/Monitoring Agency Name &amp; Address</b> Armstrong Laboratory Environics Directorate Site Remediation Division 139 Barnes Drive, Suite 2 Tyndall Air Force Base, FL 32403-5323				<b>10. Monitor Acronym</b> USAF	
				<b>11. Monitor Report #</b> AL/EQ-TR-1996-0013	
<b>12. Distribution/Availability Statement</b> Approved for public release. Distribution unlimited.					
<b>13. Supplementary Notes</b>					
<b>14. Abstract</b> Present efforts have developed photocatalysts best suited for the destruction of hydrophobic and hydrophilic organic contaminants. Using solar insolation with Pt-TiO <sub>2</sub> supported on silica gel, the best supported photocatalyst identified in a systematic evaluation, can mineralize trichloroethylene (8 mg/l) completely in a short time of 1.3 minutes. The destruction rate using this supported catalyst is four times greater than that using the optimized slurry made with the best photocatalyst identified, and sixteen times greater than using a slurry made with the best commercially available catalyst. Catalyst supports are successfully surface-modified to increase adsorption capacity and in turn the overall destruction rates. Using solar insolation or artificial light sources for the applications in both water and air phases, the fixed-bed processes utilizing the supported photocatalyst have successfully mineralized other compounds with a wide range of adsorbabilities and photoactivities. Present efforts also have developed an adsorbent regeneration strategy: using saturated steam followed by photocatalysis to regenerate the spent (continued on reverse)					
<b>15. Subject Terms</b> Catalysis, photocatalysis, adsorbent regeneration, advanced oxidation					
<b>Security Classification of</b>			<b>19. Limitation of Abstract</b>	<b>20. # of Pages</b>	<b>21. Responsible Person (Name and Telephone #)</b>
<b>16. Report</b> Unclassified	<b>17. Abstract</b> Unclassified	<b>18. This Page</b> Unclassified			

DRAFT QUALITY INSPECTED 2

### 13. Abstract (cont)

adsorbents, and to destroy the desorbed organic compounds in the steam or steam condensate. Limited efforts have been made to model photocatalysis and steam desorption. The technologies have been tested successfully in the field at Tyndall AFB, FL and K.I. Sawyer AFB, MI and at a water treatment plant in Wausau, WI.

## PREFACE

This report was prepared by Michigan Technological University (MTU), Department of Civil and Environmental Engineering, Group of Drs. John C. Crittenden, David W. Hand, and Yin Zhang, 1400 Townsend Drive, Houghton, MI 49931 under Contract No. F08635-90-C-0063, "An Evaluation of the Technical Feasibility of Photocatalytic Oxidation and Phase Transfer Catalysis for the Removal and Destruction of Contaminants from Water", for the Armstrong Laboratory Environics Directorate (AL/EQW), Tyndall Air Force Base, FL 32403-5323.

This final report describes research activities and accomplishments in the following three areas: (1) the development of highly photoactive catalysts and fixed-bed photocatalytic decontamination processes for both water and air phases; (2) the development of treatment processes using adsorption for contaminant removal and advanced oxidation processes (AOPs) for spent adsorbent regeneration; (3) the field tests and demonstrations of the developed technologies at Tyndall and K.I. Sawyer AFBs, and at a water treatment plant in Wausau, WI. In addition, the document describes the limited efforts in modeling photocatalysis and steam desorption related to the first two areas mentioned above.

This document summarizes the important activities and significant accomplishments in the three above-mentioned areas and the additional modeling efforts. Detailed descriptions on these activities and accomplishments can be found in the publications listed in Appendices B, C, D, and E: Literature Contributions, Manuscripts Submitted for Publication, Poster and Presentation Contribution, and Dissertations and Theses, respectively.

The authors wish to acknowledge the support provided by Major Mark Smith and Capt Edward Marchand, U.S. Air Force Armstrong Laboratory Environics Directorate (formerly the U.S. Air Force Engineering and Services Center), Tyndall AFB, FL.

This project was performed between 1 May 1990 and 31 December 1994.

## EXECUTIVE SUMMARY

### A. OBJECTIVE

The objectives of the above specified project are: (1) development of photocatalytic treatment technologies for contaminated water and air; (2) development of water treatment processes using adsorption for contaminant removal and advanced oxidation processes (AOPs) for spent adsorbent regeneration.

### B. BACKGROUND

Conventional water treatment technologies are granular-activated carbon (GAC) adsorption and air stripping. These technologies, however, are only applicable to organic contaminants with high adsorbability or high volatility. Furthermore, GAC adsorption and air stripping are nondestructive processes in which contaminants are transferred from one medium to another. Therefore, added treatment steps are required to render the contaminants harmless to the environment. These extra requirements complicate the remediation processes and increase treatment expenses. Scientists and engineers have been prompted to develop new treatment technologies that either destroy or immobilize contaminants at a competitive cost. Treatment technologies employing advanced oxidation processes (AOPs) are gaining momentum because they can provide complete destruction of organic contaminants in both water and air phases.

AOPs involve the generation of highly reactive radicals and can mineralize organic contaminants to nontoxic materials such as carbon dioxide, water, and mineral acids. AOPs can destroy a wide spectrum of organic contaminants including those not readily removed by air stripping and adsorption. Generally, AOPs can be classified into two groups: (1) homogeneous reactions that involve ozone and hydrogen peroxide alone or in combination, with or without ultraviolet (UV) light illumination; and (2) heterogeneous reactions that use UV light and photoactive semiconductors such as titanium dioxide ( $\text{TiO}_2$ ). The latter are also referred to as photocatalysis. In photocatalysis, the catalyst photoactivity plays an important role. However, no systematic investigations had been conducted to explore the potential of enhancing photocatalyst performance. When applying photocatalysis to water treatment, two reactor options are available: (1) the catalyst is added as a slurry and passed through the illuminated reactor, and (2) the catalyst is attached to a support in an illuminated fixed-bed reactor. Most of the water treatment studies had been conducted with slurry reactors; few had been conducted with fixed-bed reactors. One of the problems related to fixed-bed reactors might be slower kinetics due to mass transfer limitation and light penetration. A fixed-bed reactor, however, has a major advantage over slurry operations: avoiding the problems associated with liquid/catalyst separation in slurry. Enhancing overall destruction kinetics in a fixed-bed operation is also possible through the selection of suitable support material and through the development of techniques stimulating beneficial interactions between the catalyst and support.

Previous homogeneous AOP and photocatalysis studies were successful in both laboratory and field experiments. However, these studies were limited to direct destruction of organic contaminants, and made no efforts to explore the possibility for adsorbent regeneration.

"Phase-Transfer Oxidation (Catalysis)" is a treatment strategy developed in this study which includes two consecutive operational steps: (1) removal of contaminants with fixed-bed adsorption using granular activated carbon (GAC) or synthetic adsorbents, and (2) regeneration of the spent carbon or adsorbents using homogeneous AOP and photocatalysis. When using photocatalysis for regeneration, the adsorbents were impregnated with photocatalysts, which would allow the impregnated adsorbents to act as both adsorbents for capturing the organics and photocatalysts for destroying the adsorbed organics during regeneration. Furthermore, a photocatalytic process was also used in this study in combination with conventional methods (e.g., steam) to regenerate spent adsorbents.

Fast photocatalytic kinetics found in air phase offer a new approach to water treatment: water contaminated with volatile organics can be treated using air stripping followed by gas-phase photocatalysis. The treatment feasibility of this approach was investigated using the fixed-bed photocatalytic process developed in this study.

### **C. PROJECT SCOPE**

The major project activities and accomplishments were in three areas: (1) the development of catalysts of high photoactivity and a fixed-bed photocatalytic process for toxic organic destruction in both the water and air phases; (2) the development of adsorption processes with various regeneration methods involving AOPs; (3) the field tests and demonstrations of the technologies developed in this project. Other related studies were partly supported by this project.

### **D. METHODOLOGY AND TEST DESCRIPTION**

A number of photocatalysts were purchased from reputable suppliers and several photocatalysts were prepared in the MTU laboratory. Some of these photocatalysts were further modified with surface modification using noble metals or with structure doping using transition metals. The photoactivities of these catalysts were evaluated by comparing destruction rates of model compounds (both artificial UV light sources and solar radiation were used).

More than ten types of random packing and structured materials were examined as possible photocatalyst supports. Catalyst support selection was based on the following criteria: (1) adsorption capacity, (2) UV transmission, and (3) mass transfer properties. Electron-rich materials were excluded because excessive electrons may scavenge the reactive radicals, impeding photoefficiency. Five silica-based materials were selected to further test their performance in organic destruction. In order to increase the overall destruction kinetics, some silica-based support materials were surface modified to increase their adsorption capacity. A unique procedure including steps of heating and annealing was developed to prepare supported catalysts for fixed-bed reactors. In a series of solar experiments, the performance of the fixed-bed process was systematically optimized with respect to catalyst type and dosage, support type and size, and preparation methods. Moreover, the destruction of a model compound was investigated with various UV irradiance, influent concentration, pH, and hydraulic loading. The same fixed-bed process, using tanning lamps, was also tested successfully in the destruction of

several other compounds in both water and air phases. A reactor model was developed, based on the results from the water phase experiments.

In the development of processes using adsorption followed by regeneration, the operational principle consisted of two steps: (1) the organic compounds were removed and accumulated using fixed-bed adsorption, and (2) the spent adsorbents were regenerated using homogeneous AOPs, photocatalysis, or a combination of steam and photocatalysis. With the homogeneous AOPs, hydrogen peroxide/ozone and ultraviolet light/hydrogen peroxide were used for destructive adsorbent regeneration. In the case using photocatalysis, catalysts were impregnated on to the adsorbents prior to their loading with organic compounds. UV illumination was then used to simultaneously regenerate the spent adsorbents and to destroy the adsorbed organics. For both the homogeneous and heterogeneous processes, however, the destruction kinetics were slow due to the desorption of adsorbed organics from the interior to the exterior of the adsorbents where the oxidation took place. Saturated steam was found to significantly increase the desorption rates of adsorbed organics. Consequently, steam followed by photocatalysis was used off line to regenerate spent adsorbents and to clean up the regeneration fluid (the off steam or steam condensate).

Three field tests were conducted using the technologies developed in this project. The first field test was conducted to treat fuel-contaminated groundwater using the fixed-bed photocatalytic process at Tyndall AFB, FL. The contaminants of concern were benzene, toluene, ethylbenzene and xylenes (BTEX compounds). A simple pretreatment unit was developed for removing turbidity, adding oxygen, and eliminating ionic species. One reactor was kept in operation for 25 days to evaluate pretreatment effectiveness and to examine the long-term photocatalyst performance. Moreover, the test also studied the impact of flow rates, reactor diameters, influent concentrations, and weather conditions. The second field test was conducted on a pilot scale using a photocatalytic process to demonstrate treatment feasibility at K.I. Sawyer AFB, MI. A solar reactor panel comprising 80 tubular reactors was used with a flow rate of approximately one gallon per minute. The third field test was conducted at a water treatment plant in Wausau, WI. The contaminated groundwater was treated with adsorption and the spent adsorbents were regenerated off line with saturated steam followed by photocatalysis. Four cycles of adsorption and three cycles of steam regeneration were performed in this field test.

## **E. RESULTS AND CONCLUSIONS**

One of the surface-modified photocatalysts, platinumized Aldrich-TiO<sub>2</sub>, was found the best for destroying hydrophobic compounds. This catalyst has a photoactivity as much as four times that of the best commercially available catalyst (Degussa P25). A laboratory-developed photocatalyst, platinumized MTU-TiO<sub>2</sub>, was found best for more hydrophilic compounds and drinking water disinfection by-product precursors.

Using Pt-Aldrich-TiO<sub>2</sub> supported on silica gel, trichloroethylene (8 mg/L) was mineralized completely in a short contact time of 1.3 minutes. The destruction rate was four times that of the optimized slurry of Pt-Aldrich-TiO<sub>2</sub> and sixteen times that of the optimized slurry of the best commercially available catalyst. This fixed-bed process demonstrates a high



light efficiency. The ratio of organic molecules destroyed to UV photons required is 40%, much higher than other values reported which are commonly less than 5%. The reactor model developed in this project can predict the mineralization of organic compounds using only their known physical and chemical properties and the applied UV irradiance. This model will also predict solar organic destruction based on the results from tanning lamps. Based on the model prediction using a solar UV irradiance of  $2.55 \text{ mW/cm}^2$  (typical for a late afternoon in the fall in Houghton, MI), the contact times to completely mineralize trichloroethylene (9.42 mg/L), tetrachloroethylene (4.98 mg/L) and *p*-dichlorobenzene (2.35 mg/L) are less than 1.2 minutes. For 2-chlorobiphenyl (a PCB congener, 3.58 mg/L), methyl ethyl ketone (2.5 mg/L) and carbon tetrachloride (0.49 mg/L), the contact times required are 1.8, 10.9 and 17.1 minutes, respectively.

Research results proved that a supported photocatalyst had higher overall destruction rates when the same support was modified to have larger adsorption capacity. In this study, silica gel supports were silylated with dimethyldichlorosilane to create more hydrophobic surfaces. Adsorption isotherms and breakthrough curves of the modified supports demonstrated support modification can definitely increase adsorption capacities. For trichloroethylene destruction, the overall kinetics is 50% faster when the aqueous adsorption capacity of silica gel and silylated silica gel supports were 16 and 24 times higher than using the best commercially available  $\text{TiO}_2$  catalysts (e.g., Degussa P25) in slurry form.

Much faster kinetics was observed in the air-phase than in the water phase. This faster air-phase kinetics offers the treatment possibility of stripping volatile compounds from water followed by applying air-phase photocatalysis. Relative humidity and chlorine radical interactions were found to have a significant impact on air-phase reactions. Phosgene and carbon monoxide, the two major toxic by-products in air-phase photocatalysis, were not found above regulated levels.

While the strategy using steam combined with photocatalysis proved successful, the heterogeneous AOP (hydrogen peroxide/ozone and ultraviolet light/hydrogen peroxide) and direct photocatalysis ( $\text{TiO}_2$  impregnated adsorbents) options encountered difficulties. In both the homogeneous AOP options, more oxidants were consumed in the regeneration processes than would be required to destroy the organic contaminants directly using a conventional AOP. Furthermore, using either the homogeneous AOP or the direct photocatalysis options, regeneration appears to be limited by adsorbate desorption from the interior to the exterior adsorbent surface. On the other hand, the regeneration strategy using saturated steam can overcome desorption limitation even for compounds with high boiling points. Steam followed by photocatalysis was very effective to regenerate the spent adsorbents and to destroy the desorbed organic compounds in the off-steam or steam condensate. Using steam regeneration process with six cycles of adsorption and regeneration, the adsorption capacities of the adsorbent were completely recovered for four representative compounds (tetrachloroethylene, *p*-dichlorobenzene, carbon tetrachloride and methyl ethyl ketone). For a strongly adsorbed compound (2-chlorobiphenyl), about 20% adsorbent capacity was lost after the first cycle, but the adsorption capacities for Cycles 2 through 6 remained essentially the same. Organic compounds in the condensate were destroyed effectively using the photocatalytic fixed-bed

process. Preliminary modeling appeared promising in describing desorption in the steam regeneration process.

Based on laboratory studies, field tests were conducted using the proven options: (1) a photocatalytic fixed-bed process, and (2) a process combining adsorption and adsorbent regeneration using steam followed by photocatalysis. In the field test conducted at Tyndall Air Force Base, ionic species were found primarily responsible for photocatalyst fouling. Using the pretreatment developed for this test, no loss in catalyst photoactivity was found for 25 days of continuous operation. On a rainy day, BTEX compounds (total influent concentration of approximately 2 mg/L) were destroyed within 2.6 minutes. Moreover, test results with various flow rates, reactor diameters, influent concentrations, solar irradiances and weather conditions confirmed the application potential of the process. In the pilot scale field test at K.I. Sawyer AFB, MI, the destruction of chlorinated contaminants in the groundwater was demonstrated using a fixed-bed reactor panel. The panel performance was found comparable with a tube reactor under identical conditions. In the field test conducted in Wausau, WI, a spent synthetic adsorbent was successfully regenerated using saturated steam with 20 hours. In comparison, a spent activated carbon was not effectively regenerated for capacity recovery. The condensate from steam regeneration was treated using photocatalysis for approximately 35 minutes to destroy the desorbed high-concentration adsorbates.

# TABLE OF CONTENTS

Section	Title	Page
I	INTRODUCTION .....	1
A.	OBJECTIVE .....	1
B.	BACKGROUND .....	1
C.	SCOPE .....	3
D.	APPROACH .....	3
	1. Development of Photocatalytic Treatment Processes .....	3
	2. Process Using Adsorption and Regeneration with AOPs .....	4
	3. Field Test and Demonstration of Developed Technologies .....	5
II	DEVELOPMENT OF PHOTOCATALYTIC TREATMENT PROCESSES ...	6
A.	PHOTOCATALYST EVALUATION AND DEVELOPMENT .....	6
	1. Evaluation of Unmodified Photocatalysts .....	7
	2. Development of Surface-Modified Photocatalysts .....	8
	3. Development of Structure-Doped Photocatalysts .....	10
B.	DEVELOPMENT OF FIXED-BED PROCESS .....	11
	1. Evaluation of Materials as Photocatalyst Supports .....	11
	2. Silica-Based Materials as Photocatalyst Supports .....	13
C.	KINETICS ENHANCEMENT BY ADSORPTION .....	14
D.	INVESTIGATION OF PHOTOCATALYSIS IN GAS-PHASE .....	16
E.	KINETICS STUDIES AND PHOTOCATALYSIS MODELING .....	17
	1. Modeling Based on Fixed-Bed Photocatalysis .....	17
	2. Modeling Based on Slurry Photocatalysis .....	20
III.	PROCESSES USING ADSORPTION AND REGENERATION .....	21
A.	HOMOGENEOUS AOPs FOR ADSORBENT REGENERATION ....	21
B.	PHOTOCATALYSIS FOR DESTRUCTION AND REGENERATION ..	22
	1. Photocatalysis Alone for Adsorbent Regeneration .....	22
	2. Steam Followed by Photocatalysis for Regeneration .....	26

C.	MODELING ON STEAM ENHANCED DESORPTION .....	26
IV.	FIELD TESTS AND DEMONSTRATIONS .....	28
A.	SMALL SCALE FIELD TESTS AT TYNDALL AFB .....	28
1.	Test Using Photocatalyst Supported on Silica Gel .....	29
2.	Test Using Photocatalyst Supported on Adsorbents .....	31
B.	FIELD DEMONSTRATION AT K.I. SAWYER, AFB .....	32
C.	FIELD TEST AT WATER TREATMENT PLANT IN WAUSAU .....	35
V	CONCLUSIONS AND RECOMMENDATIONS .....	36
A.	CONCLUSIONS .....	36
B.	RECOMMENDATIONS .....	38

## APPENDIX

A.	REFERENCES .....	41
B.	LITERATURE CONTRIBUTION .....	44
C.	MANUSCRIPTS SUBMITTED FOR PUBLICATION .....	46
D.	POSTER AND PRESENTATION CONTRIBUTION .....	47
E.	DISSERTATIONS AND THESES .....	50

## LIST OF FIGURES

Figure		Page
1	Schematic of the slurry reactor using a mercury lamp . . . . .	7
2	Destruction of TCE using different TiO <sub>2</sub> photocatalysts . . . . .	9
3	Performance comparison of best slurry and best supported photocatalysts . . . . .	12
4	Comparison of TCE destruction with chloride ion production to evaluate the degree of mineralization . . . . .	13
5	Simulation of day-night cycles (destruction/adsorption) . . . . .	15
6	Solar destruction of TCE on a rainy day . . . . .	18
7	Comparison of experimental data and model prediction for destruction of PCE, <i>p</i> -DCB and 2-PCB . . . . .	19
8	Experimental data comparison and model prediction for CTC and MEK destruction . . . . .	19
9	TCE concentration profiles of impregnated F-400 . . . . .	23
10	Schematic of the steam regeneration unit . . . . .	24
11	<i>p</i> -DCB adsorption profiles with Amborsorb® 563 adsorbents . . . . .	25
12	2-PCB adsorption profiles with Amborsorb® 563 adsorbents . . . . .	25
13	Schematic of the experimental setup used for the field test at Tyndall AFB . . . . .	29
14	BTEX destruction in an experiment conducted on a rainy day . . . . .	30
15	Schematic of the layout for a field demonstration . . . . .	35

## LIST OF TABLES

TABLE	TITLE	PAGE
1	EBCTS REQUIRED FOR COMPLETE MINERALIZATION OF SELECTED ORGANIC COMPOUNDS . . . . .	16
2	CALCULATED GAS-PHASE DETENTION TIMES FOR PHOTOCATALYTIC DESTRUCTION OF SELECTED VOCS . . . . .	32

# SECTION I

## INTRODUCTION

### A. OBJECTIVE

The objectives of the project are: (1) development of photocatalytic treatment technologies for contaminated water and air; (2) development of water treatment processes using adsorption for contaminant removal and advanced oxidation processes (AOPs) for spent adsorbent regeneration.

### B. BACKGROUND

Conventional water treatment technologies are granular-activated carbon (GAC) adsorption and air stripping. These technologies, however, are only applicable to organic contaminants with high adsorbability or high volatility. Further, GAC adsorption and air stripping are nondestructive processes in which contaminants are transferred from one medium to another. Therefore, added treatment steps are required to render the contaminants harmless to the environment. These extra requirements complicate the remediation processes and increase treatment expenses. Scientists and engineers have been prompted to develop new treatment technologies that either destroy or immobilize contaminants at a competitive cost. Treatment technologies employing advanced oxidation processes (AOPs) are gaining momentum because they can provide complete destruction of organic contaminants in both water and air phases.

AOPs involve the generation of highly reactive radicals and can mineralize organic contaminants to nontoxic materials such as carbon dioxide, water, and mineral acids. AOPs can destroy a wide spectrum of organic contaminants including those not readily removed by air stripping and adsorption. Generally, AOPs can be classified into two groups: (1) homogeneous reactions that involve ozone and hydrogen peroxide alone or in combination, with or without ultraviolet (UV) light illumination; and (2) heterogeneous

reactions that use UV light and photoactive semiconductors such as titanium dioxide ( $\text{TiO}_2$ ). The latter are often referred to as photocatalysis which can mineralize organic contaminants in both the water [1,2,3] and air phases [4,5,6,7]. In photocatalysis, the catalyst photoactivity plays an important role. However, no systematic investigations had been conducted to explore the potential of enhancing photocatalyst performance. When applying photocatalysis to water treatment, two reactor options are available: (1) the catalyst is added as a slurry and passed through the illuminated reactor, and (2) the catalyst is attached to a support in an illuminated fixed-bed reactor. Most of the water treatment studies had been conducted with slurry reactors; few had been conducted with fixed-bed reactors. One of the problems related to fixed-bed reactors might be slower kinetics due to mass transfer limitation and light penetration. A fixed-bed reactor, however, has a major advantage over slurry operations: avoiding the problems associated with liquid/catalyst separation in slurry. Enhancing overall destruction kinetics in a fixed-bed operation is also possible through the selection of suitable support material and through the development of techniques stimulating beneficial interactions between the catalyst and support.

Previous homogeneous AOP and photocatalysis studies were successful in both laboratory and field experiments. However, these studies were limited to direct destruction of organic contaminants, and made no efforts to explore the possibility for adsorbent regeneration. "Phase-Transfer Oxidation (Catalysis)" is a treatment strategy developed in this study which includes two consecutive operational steps: (1) removal of contaminants with fixed-bed adsorption using granular activated carbon (GAC) or synthetic adsorbents, and (2) regeneration of the spent carbon or adsorbents using homogeneous AOP and photocatalysis. When using photocatalysis for regeneration, the adsorbents were impregnated with photocatalysts which would allow the impregnated adsorbents to act as both adsorbents for capturing the organics and photocatalysts for



destroying the adsorbed organics during regeneration. Further, a photocatalytic process was also used in this study in combination with conventional methods (e.g., steam) to regenerate spent adsorbents.

Fast photocatalytic kinetics found in air phase offer a new approach to water treatment: water contaminated with volatile organics can be treated using air stripping followed by gas-phase photocatalysis. The treatment feasibility of this approach was investigated using the fixed-bed photocatalytic process developed in this study.

### **C. SCOPE**

The major project activities and accomplishments were in three areas: (1) the development of catalysts of high photoactivity and a fixed-bed photocatalytic process for toxic organic destruction in both the water and air phases; (2) the development of adsorption processes with various regeneration methods involving AOPs; (3) the field tests and demonstrations of the technologies developed in this project. Other related studies were partly supported by this project.

### **D. APPROACH**

#### ***1. Development of Photocatalytic Treatment Processes***

A number of photocatalysts were purchased from reputable suppliers and several photocatalysts were prepared in the MTU laboratory. Some of these photocatalysts were further modified with surface modification using noble metals or with structure doping using transition metals. The photoactivities of these catalysts were evaluated by comparing destruction rates of model compounds (both artificial UV light sources and solar radiation were used).

More than ten types of random packing and structured materials were examined as possible photocatalyst supports. Catalyst support selection was based on the

following criteria: (1) adsorption capacity, (2) UV transmission, and (3) mass transfer properties. Electron-rich materials were excluded because excessive electrons may scavenge the reactive radicals impeding photoefficiency. Five silica-based materials were selected to further test their performance in organic destruction. In order to increase the overall destruction kinetics, some silica-based support materials were surface modified to increase their adsorption capacity. A unique procedure including steps of heating and annealing was developed to prepare supported catalysts for fixed-bed reactors. In a series of solar experiments, the performance of the fixed-bed process was systematically optimized with respect to catalyst type and dosage, support type and size, and preparation methods. Moreover, the destruction of a model compound was investigated with various UV irradiance, influent concentration, pH, and hydraulic loading. The same fixed-bed process, using tanning lamps, was also tested successfully in the destruction of several other compounds in both water and air phases. A reactor model was developed, based on the results from the water phase experiments.

## ***2. Process Using Adsorption and Regeneration with AOPs***

In the development of processes using adsorption followed by regeneration, the operational principle consisted of two steps: (1) the organic compounds were removed and accumulated using fixed-bed adsorption, and (2) the spent adsorbents were regenerated using homogeneous AOPs, photocatalysis, or a combination of steam and photocatalysis. With the homogeneous AOPs, hydrogen peroxide/ozone and ultraviolet light/hydrogen peroxide were used for destructive adsorbent regeneration. In the case using photocatalysis, catalysts were impregnated on to the adsorbents prior to their loading with organic compounds. UV illumination was then used to simultaneously regenerate the spent adsorbents and to destroy the adsorbed organics. For both the homogeneous and heterogeneous processes, however, the destruction kinetics were slow due to the desorption of adsorbed organics from the interior to the exterior of the adsorbents where the oxidation

took place. Saturated steam was found to significantly increase the desorption rates of adsorbed organics. Consequently, steam followed by photocatalysis was used off line to regenerate spent adsorbents and to clean up the regeneration fluid (the off steam or steam condensate).

### ***3. Field Test and Demonstration of Developed Technologies***

Three field tests were conducted using the technologies developed in this project. The first field test was conducted to treat fuel-contaminated groundwater using the fixed-bed photocatalytic process at Tyndall AFB, FL. The contaminants of concern were benzene, toluene, ethylbenzene and xylenes (BTEX compounds). A simple pretreatment unit was developed for removing turbidity, adding oxygen, and eliminating ionic species. One reactor was kept in operation for 25 days to evaluate pretreatment effectiveness and to examine the long-term photocatalyst performance. Moreover, the test also studied the impact of flow rates, reactor diameters, influent concentrations, and weather conditions. The second field test was conducted on a pilot scale using a photocatalytic process to demonstrate treatment feasibility at K. I. Sawyer AFB, MI. A solar reactor panel comprising 80 tubular reactors was used with a flow rate of approximately one gallon per minute. The third field test was conducted at a water treatment plant in Wausau, WI. The contaminated groundwater was treated with adsorption and the spent adsorbents were regenerated off line with saturated steam followed by photocatalysis. Four cycles of adsorption and three cycles of steam regeneration were performed in this field test.

## SECTION II

### DEVELOPMENT OF PHOTOCATALYTIC TREATMENT PROCESSES

#### A. PHOTOCATALYST EVALUATION AND DEVELOPMENT (*As described by Literature Contribution 1; Liu's Ph.D. Dissertation; and Suri's and Rollman's M. S. Theses*)

The activity of a photocatalyst plays an important role. According to Link [8], if the light requirement for photocatalysis could be reduced by a factor of three, photocatalysis using solar energy would be a cost-competitive alternative to environmental remediation technologies such as granular-activated carbon adsorption and UV-hydrogen peroxide oxidation. Both commercially available catalysts and catalysts prepared in the MTU laboratory were examined in this part of the study.

Anatase form titanium dioxide ( $\text{TiO}_2$ ) has been the most commonly used photocatalyst. In this study, the performance of two widely used commercial  $\text{TiO}_2$  products and several laboratory-made or laboratory-modified photocatalysts were evaluated, based on the results of organic destruction experiments. The catalyst modification was focused in two areas: (1) surface modification of commercially available catalysts, and (2) metal doping of catalysts during synthesis. The main objective of this study was to compare a variety of catalysts to determine those that use the least amount of light energy to destroy a given compound.

Batch rate tests were performed with aqueous suspensions of the catalysts, using both solar radiation and artificial lights. Variables known to have impact on the photocatalytic reaction rate were evaluated: (1) the catalyst dosage; (2) the organic compound type and initial concentrations; (3) the light intensity; (4) the reactor configuration; (5) and the electron acceptor type and concentration. The schematic of the reactor used in these screening tests is shown in Figure 1.

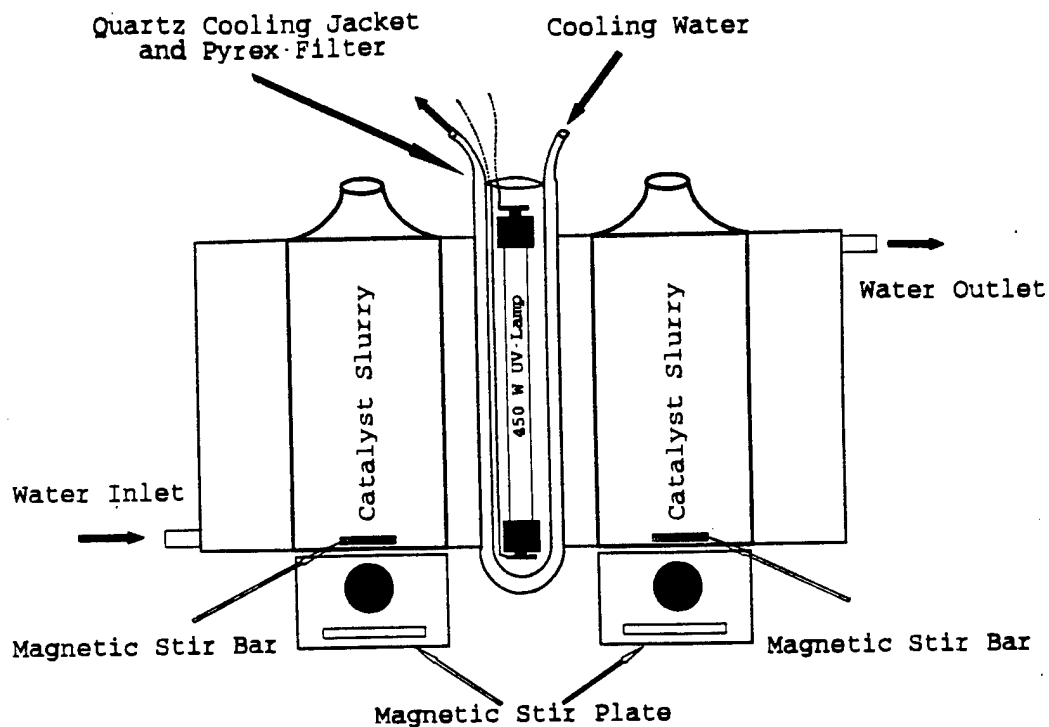

Figure 1. Schematic of the slurry reactor using a mercury lamp.

### 1. *Evaluation of Unmodified Photocatalysts*

The commercially available photocatalysts purchased and tested in this study were: (1) Aldrich  $\text{TiO}_2$  obtained from Aldrich Chemical Co. (Milwaukee, WI); (2) P25 Degussa  $\text{TiO}_2$  obtained from Degussa Chemical Co. (Ridgefield Park, NJ); (3)  $\text{SrTiO}_3$  obtained from GSI, Inc. (Carle Place, NY).

The photocatalysts developed in the laboratory at MTU were: (1) MTU- $\text{TiO}_2$  prepared using a sol-gel process [9], (2)  $\text{SrTiO}_3$  prepared from aqueous  $\text{Sr}(\text{NO}_3)_2$  and Tyzor LA reagent (organic titanate) from DuPont (Wilmington, DE) as described elsewhere [10], (3) nickel oxide on strontium titanate (1.5%  $\text{NiO-SrTiO}_3$ ) prepared by thermally reducing  $\text{NiO}$  on the surface of  $\text{SrTiO}_3$  from aqueous  $\text{Ni}(\text{NO}_3)_2$  followed by reduction and reoxidation treatments as described by Domen, et al., (1986) [11], and (4)

nickel oxide on strontium titanate (1.5% NiO-SrTiO<sub>3</sub>) prepared by a photo-reduction method in which an aqueous solution of Ni(NO<sub>3</sub>)<sub>2</sub> was photo-reduced onto SrTiO<sub>3</sub> followed by reoxidation as described elsewhere [10].

Of the photocatalysts tested, plain TiO<sub>2</sub> had the best performance; consequently, subsequent efforts focused on surface modification and substitutional doping to further improve TiO<sub>2</sub> performance.

## 2. *Development of Surface-Modified Photocatalysts*

The objective of this part of the study was to improve the photocatalytic activity of TiO<sub>2</sub> using different surface modification methods and chemicals, and to identify the most active photocatalyst for the destruction of organic contaminants in water. The materials used for surface modification in this study were limited to metals and metal oxides. Organic dyes, which were reported for catalyst sensitization [12], were not included.

MTU TiO<sub>2</sub> and Degussa P25 were surface-modified using platinum. Aldrich TiO<sub>2</sub> was surface-modified with platinum, silver and iron oxide. Aldrich TiO<sub>2</sub> was also used to evaluate the impact of methods for surface modification on the photoactivity. The methods used for the surface modification of the catalysts are as follows: (1) platinizing TiO<sub>2</sub> by photo-reducing platinum on the surface of TiO<sub>2</sub> from hexachloroplatinic acid, as described by Kraeutler and Bard [10] and modified by Hand et al [11]; (2) platinizing or silverizing TiO<sub>2</sub> by chemically depositing the metal onto the catalyst surface by mixing a metal salt and TiO<sub>2</sub> in a deionized aqueous solution; and (3) surface-modifying TiO<sub>2</sub> with iron oxide by depositing the metal oxide onto the TiO<sub>2</sub> catalyst surface in a ferric chloride solution after adjusting the solution pH with sodium hydroxide.

Organic compounds used in destruction experiments to identify the best photocatalyst were: trichloroethylene (TCE), toluene, methyl ethyl ketone (MEK), salicylic acid, and 2,4-dichlorophenol. The results demonstrated that best catalyst performance

depended on the organic compound to be destroyed. The best results for the destruction of hydrophobic compounds such as TCE, toluene, and MEK were obtained with 1% Pt-Aldrich TiO<sub>2</sub> catalyst. On the other hand, the best results for the destruction of more hydrophilic compounds such as salicylic acid and 2,4-dichlorophenol were obtained with 1% Pt-MTU TiO<sub>2</sub>. With two surface waters, Hand [9] reported the 1% Pt-MTU TiO<sub>2</sub> catalyst showed the best destruction kinetics for nonpurgeable organic carbon and disinfection by-product formation potential. In addition to maximum destruction of the parent compounds, the more active catalysts produced fewer by-products for a given amount of destruction.

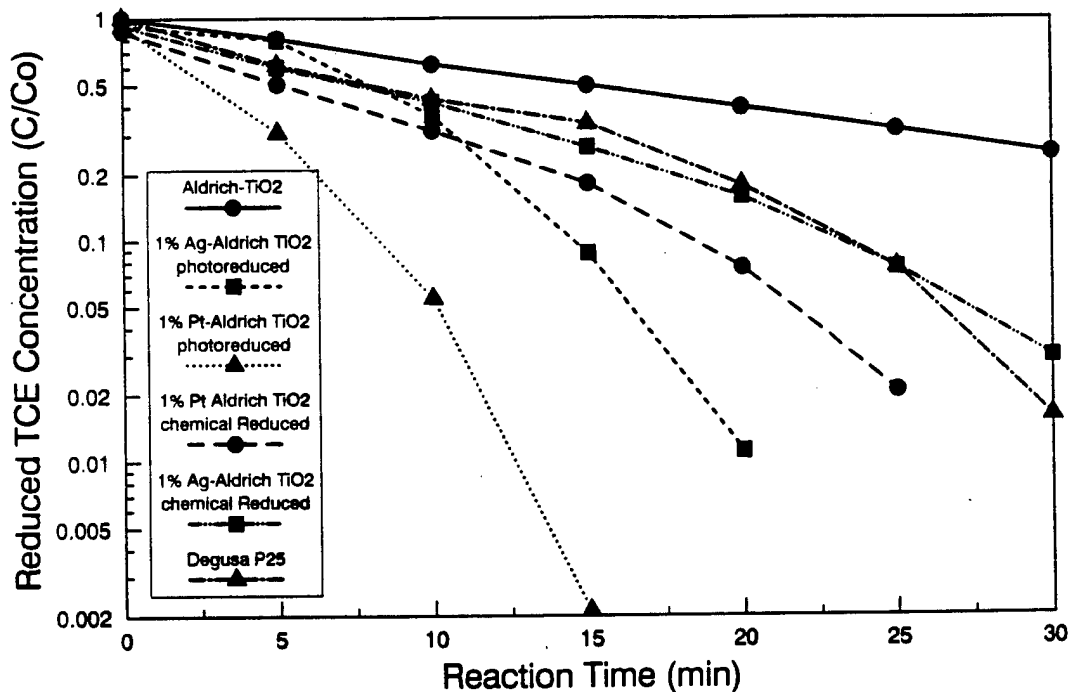

Figure 2. Destruction of TCE using different TiO<sub>2</sub> photocatalysts. The initial concentration is 15 mg/L.

Figure 2 displays the destruction of TCE using platinized and silverized TiO<sub>2</sub> prepared by different methods. According to Figure 2, there is a tremendous potential to

increase the process efficiency by developing photocatalysts more active than those commercially available. For example, the time required to destroy 90% of 10 mg/L initial TCE concentration decreased by a factor of four using the best laboratory-prepared catalyst, 1.0% Pt-Aldrich TiO<sub>2</sub>, as compared with the best commercially available catalyst, Degussa P25. This implies that the amount of light energy required for the same degree of destruction is decreased by a factor of about four.

The 1.0% Pt-Aldrich TiO<sub>2</sub> made by MTU was tested by the National Renewable Energy Laboratory (NREL) in Boulder, CO and was found to be the most active catalyst ever tested for destroying hydrophobic organic pollutants [15].

### *3. Development of Structure-Doped Photocatalysts*

In another study phase of photocatalyst development, catalysts were modified by doping the TiO<sub>2</sub> structure with transition metals. By doping the titanium dioxide with transition metals, the photocatalyst light response may be extended toward visible light [16-18]. Normally, wavelengths less than 387 nm are required to activate anatase TiO<sub>2</sub> and consequently only about 4% of the solar insolation can be utilized. This investigation aimed at utilizing some solar photons with wavelengths longer than 387 nm.

A low-temperature sol-gel process similar to the one proposed by Yan and Rhodes [19] and perfected by Hand [9] was used for the doped TiO<sub>2</sub> catalyst preparation. This process involves the hydrolysis of titanium (IV) isopropoxide in the presence of the doping metal ions. Cobalt, molybdenum, iron, and ruthenium were used to dope TiO<sub>2</sub>. The doped photocatalysts were fixed or supported onto support materials and tested using both artificial light and sunlight [20, 21]. The method used to fix the catalyst to the support is described in the next section of this report.

The metal-doping, however, did not increase the overall activity of TiO<sub>2</sub> in both sunlight and artificial light experiments.



**B. DEVELOPMENT OF FIXED-BED PHOTOCATALYTIC PROCESSES** (*As described by Literature Contribution 2-7, 9-10; Zhang's Ph.D. Dissertation; and Egorova-Cheesemen and Rollman's M. S. Theses*)

The two reactor design options for destroying aqueous-phase organic contaminants by photocatalysis are: (1) the catalyst is added as a slurry and passed through a lighted reactor, and (2) the catalyst is attached to a support in a lighted fixed-bed reactor. The major advantage using a fixed-bed process over slurry operations is avoiding the problems associated with liquid/solid separation. Enhancing the overall destruction kinetics in a fixed-bed process is possible by selecting suitable support material and developing techniques to optimize supported catalysts.

**1. Evaluation of Materials as Photocatalyst Supports**

The most desirable properties of a photocatalyst support are: (1) good UV transmission; (2) large adsorption capacity; and (3) chemical inertness. The primary choices of support candidates are carbonaceous adsorbents and silica-based materials. Carbonaceous adsorbents usually have high adsorption capacities but are lack the desired UV transparency. In addition, carbonaceous adsorbents are rich in undesired electrons. Using an electron rich material as a photocatalyst support may promote hole and/or radical scavenging and thus impede photoefficiency. Silica-based materials have good UV transmission but usually do not exhibit the desired adsorption capacity. Moreover, mass transfer must also be considered in the selection of a suitable photocatalyst support. Therefore, identifying a support material with desired properties becomes the first challenging task in developing a fixed-bed photocatalytic process. The studies using carbonaceous adsorbents as photocatalyst supports are discussed in SECTION III.

The following materials were evaluated as potential supports, based on the above specified criteria: (1-6 together) Ceramic Foams (Selee Corp., Hendersonville, NC) including 10, 30, and 50 pore per inch (ppi) alumina; 10 and 25 ppi mullite; and 10, 15,

and 25 ppi high purity mullite ceramic foams; (7) Ceramic Foam, 10 ppi alumina impregnated with  $\text{TiO}_2$  (Hi-Tech Ceramics, Inc., Alfred, NY); (8) Fiber glass with and without  $\text{TiO}_2$  (Nulite, Nutech Energy Systems, Inc., London, Ontario, Canada); (9-13) Silica beads with diameters ranging from 210-1080  $\mu\text{m}$  (Sigma Chemical Co., St. Louis, MO); (14) 3 mm diameter beads (Aldrich Chemical Co., Milwaukee, WI) Raschig rings, nominal diameter 5 mm (Aldrich Chemical Co., Milwaukee, WI); (15-22) Hollow silica beads, extensospheres SG, CG, MS-SG, MS-CG, Q-CEL640, Q-CEL-650; and surface modified extensospheres SG and CG (PQ Corp., Chattanooga, TN); (23) Silica gel, Davisil, (Aldrich Chemical Co., Milwaukee, WI).

Based on the results of support material light transmission experiments and mass transfer considerations, five silica-based materials were selected to conduct organic destruction experiments. These materials were (1) sand, (2) glass beads, (3) glass wool, (4) fiber glass, and (5) silica gel.

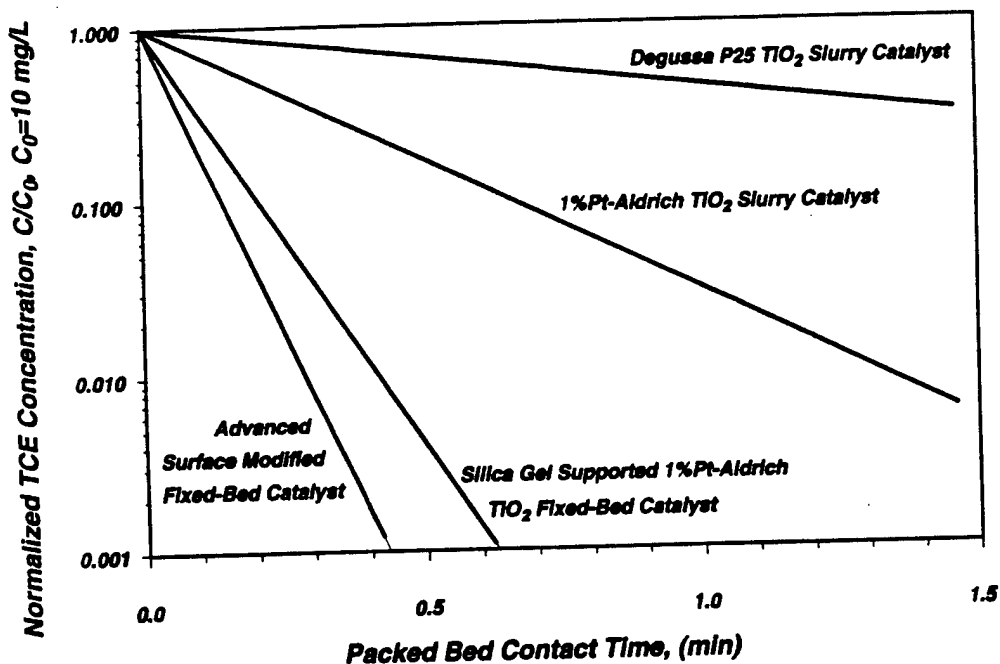

Figure 3. Comparison of the performances of best slurry and supported photocatalysts for the destruction of TCE under identical conditions.

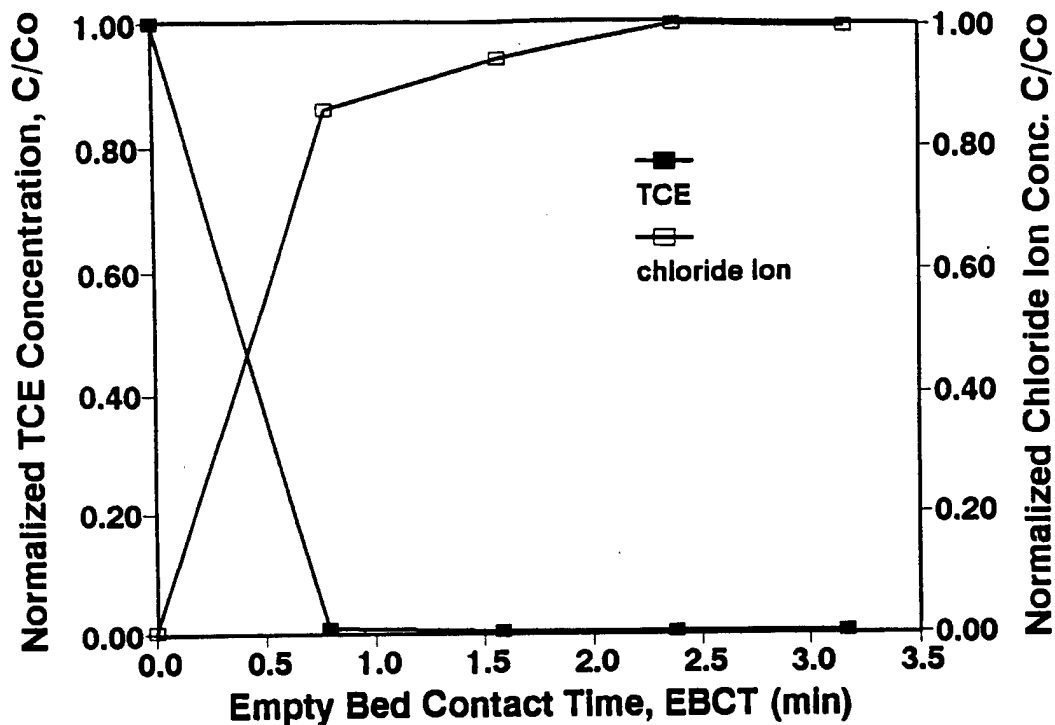

Figure 4. Comparison of TCE destruction with chloride ion production to evaluate the degree of mineralization. The influent concentration was 2.4 mg/L.

## 2. Silica-Based Materials as Photocatalyst Supports

A fixed-bed photocatalytic process for water detoxification was developed employing the best photocatalyst for chlorinated compounds, 1.0% Pt-Aldrich  $\text{TiO}_2$ . Using TCE as a model compound, the supported photocatalysts were systematically optimized with respect to catalyst type and dosage; support type and size; and preparation methods. Figure 3 compares these reactor options for the destruction of TCE under identical conditions: (1) best commercially available photocatalyst as a slurry (Degussa P25), (2) the best laboratory prepared photocatalyst 1.0% Pt-Aldrich  $\text{TiO}_2$  as a slurry, (3) the best support, silica gel, impregnated with 1.0% Pt-Aldrich  $\text{TiO}_2$ , and (4) the best surface-modified support, silica gel, impregnated with 1.0% Pt-Aldrich  $\text{TiO}_2$ . With further kinetic analysis, option (3) had a destruction rate 16 times faster than option (1). The rate

in option (3) was four times faster than in option (2). The photocatalytic destruction of TCE using the best supported catalyst option (1.0% Pt-Aldrich  $\text{TiO}_2$  on silica gel) was also investigated with various UV irradiances, influent concentrations, pH values, and hydraulic loadings. As shown in Figure 4, the supported photocatalyst can completely mineralize TCE (2.4 mg/L) in an empty bed contact time (EBCT) of 3.2 minutes. EBCT is defined as the volume of the empty bed divided by the flow rate. Accordingly, fluid residence time or reaction time within the reactor is much shorter (39% of the EBCT). This fixed-bed process has high photoefficiency and has shown an apparent quantum yield as high as 40% [20]. The apparent quantum yield is defined as the ratio of the moles of organic compound degraded to the einsteins of photons received by the photoreactor in the effective wavelength range of the photocatalyst used. Table 1 shows the EBCTs required for mineralization of organic contaminants using this fixed-bed process.

### **C. ENHANCEMENT IN PHOTOCATALYSIS KINETICS BY ADSORPTION** *(As described by Egorova-Cheesemen's M. S. Thesis)*

This part of the study examined the potential of improving overall destruction kinetics by increasing adsorption capacity of the silica-based supports. Two silica-based adsorbent materials, silica gel and Vycor glass, were modified to increase surface hydrophobicity and the adsorption capacity for non polar organic water pollutants. While this was a successful approach for silica gel, kinetics enhancement was not observed for modified Vycor glass.

The modification procedure consisted of dehydroxylation and silylation. Platinized Aldrich  $\text{TiO}_2$  was fixed onto the two modified support materials. TCE was used as a model compound to investigate the modification effectiveness. Isotherm experiments were performed using the bottle point method [22]. Results from adsorption isotherms and breakthrough curves in a packed-bed adsorber with the supports showed that support modification can definitely increase adsorption capacities. For example, isotherm results

showed the adsorption capacity of silica gel for TCE in water increased by more than a factor of five.

Thermal gravimetric analyses and Raman spectroscopy also demonstrated that supports were more hydrophobic after modification. The modification does not degrade optical properties of the material, and may have even enhanced them [23]. When used as a support for Pt-TiO<sub>2</sub>, the modified silica gel showed faster overall photocatalytic degradation kinetics for TCE than did the unmodified silica gel shown in Figure 3. A simulation of day-night cycles is shown in Figure 5.

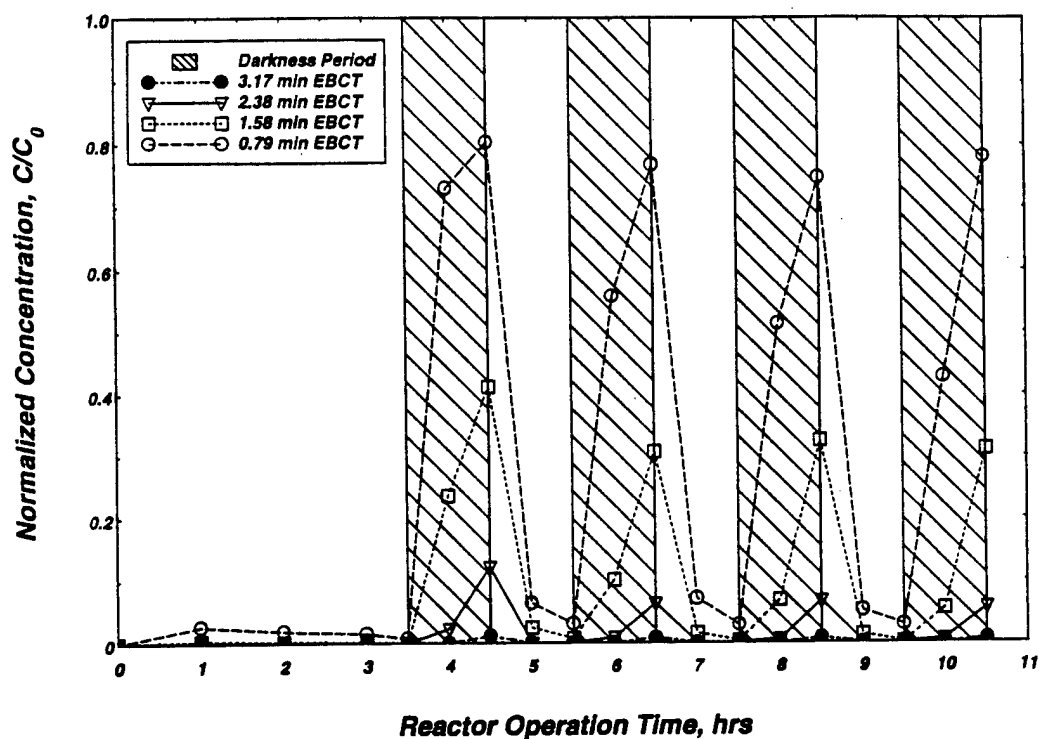

Figure 5. Simulation of day-night cycles (photo-destruction/adsorption of TCE). Initial concentration is 3.6 mg/L.

A drawback of dehydroxylation/silylation surface modification is that long exposure to UV light degrades the alkylsilane surface layer. Adsorption capacity of the modified silica gel resumed its original value (before modification) after approximately 80 hours of UV exposure.

**D. INVESTIGATION OF PHOTOCATALYSIS IN GAS-PHASE** (*As described by Rollman's M. S. Thesis, 1994*)

Based on the success using the fixed-bed process in the water phase and the successes using other fixed-bed processes in the air phase reported in the literature [4,5,6,7], several preliminary experiments were conducted using the best catalyst/support combination to investigate the feasibility in air.

Table 1. EBCTs required for mineralization of selected organic compounds.

Organic Compound Concentration (mg/L)	Tanning Lamp (1.8 mW/cm <sup>2</sup> ) Packed-Bed Contact Time (min)	Rainy Solar UV (0.17 mW/cm <sup>2</sup> ) Packed-Bed Contact Time (min)
TCE (8.81)	<3.2 <sup>a</sup>	5.4 <sup>b</sup>
PCE (4.98)	<3.2 <sup>a</sup>	2.5 <sup>b</sup>
p-DCB (2.35)	<3.2 <sup>a</sup>	2.7 <sup>b</sup>
CTC (0.49)	43 <sup>b</sup>	107 <sup>b</sup>
2-PCB (3.58)	<3.2 <sup>a</sup>	2.7 <sup>b</sup>
MEK (2.50)	27 <sup>b</sup>	70 <sup>b</sup>

- <sup>a</sup> Determined by chloride ion production in experiments (<5 μg/L).
- <sup>b</sup> Determined by reactor model prediction (99.99% destruction).

In contrast to liquid-phase photocatalysis, relative humidity and chlorine radical interactions may have a significant impact on gas-phase reactions. Therefore, gas-phase process variables that effect this technology include water vapor content, catalyst type, and type of organic compound to be destroyed. The impacts of these variables were investigated in a series of experiments using the fixed-bed photoreactor developed in early aqueous phase studies. Tanning lamps were used as the light source. TCE, 1,1,1-

trichloroethane (TCA), and toluene destruction rates were examined at different humidities. The volatile organic compounds were injected into a 200-liter Tedlar® bag (SKC, Inc., Houston, TX) containing breathing air (medical grade) and pumped through the reactor. Samples were taken and analyzed by an on-line gas chromatograph. As shown in Table 1, much faster destruction kinetics was observed in the gas phase than in the aqueous phase, offering the possibility of stripping volatile compounds followed by gas-phase destruction using photocatalysis.

For TCA, a relative humidity of 25% yielded the best destruction rate, whereas the destruction of toluene increased with increasing water vapor content. TCE was most easily oxidized and the humidity did not have a large impact on the destruction rate. Overall, the experiments demonstrated the effectiveness of this process for the oxidation of volatile organic compounds (VOCs). Phosgene and carbon monoxide, both toxic by-products reported by others [4-7], were not found above regulated levels.

#### **E. KINETICS STUDIES AND PHOTOCATALYSIS MODELING** (*As described by Literature Contribution 9; Zhang and Liu's Ph.D. Dissertation*)

Tradeoffs among the following factors must be considered in designing a photocatalytic reactor: (1) reactor size, (2) retention time, (3) catalyst dosage and (4) light intensity. This section discusses the development of models while taking the above mentioned effects into account. Combining with economic analysis, these models may be used to design treatment systems that are less expensive and more flexible.

##### **1. Modeling Based on Fix-Bed Photocatalysis**

A reactor model was developed to predict the mineralization of chlorinated, oxygenated aromatic and aliphatic compounds using known physical and chemical properties of the compounds and the applied light intensity.

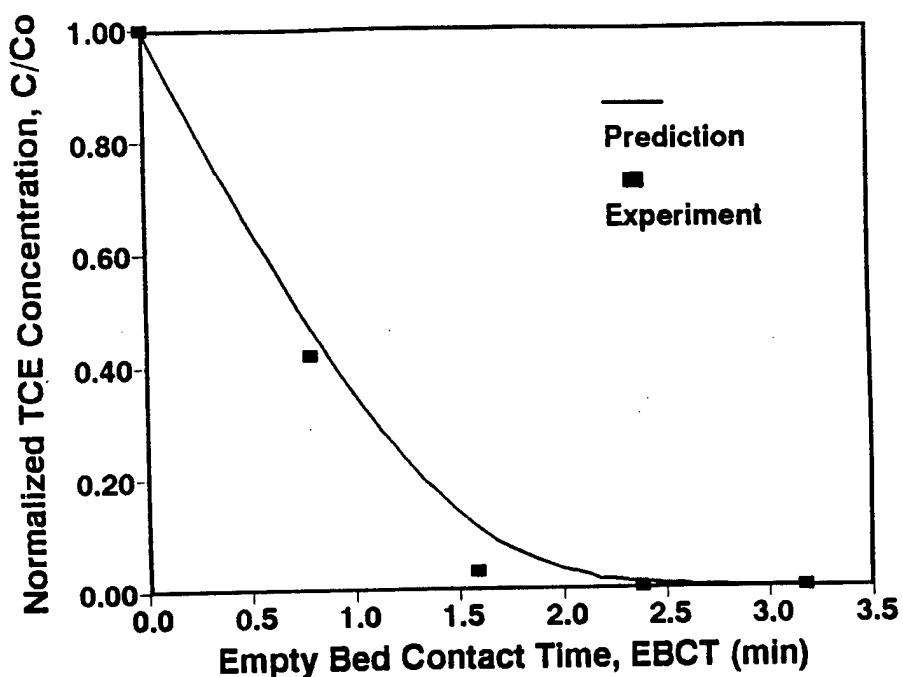

Figure 6. Solar destruction of TCE on a rainy day. The symbols were experimental data while the curve is model prediction. Influent concentration was 8.81 mg/L.

The Langmuir-Hinshelwood (L-H) form rate expression was used to describe the destruction rate and the rate constants were obtained using predictive methods. Detailed studies were conducted with TCE to determine the impacts of light intensity, influent organic concentration, type of catalyst and support, catalyst dosage, reactor configuration. Based on the results of these studies, the rate constants were predicted using the measured light intensity and compound specific properties: 1) OH rate constants, 2) solubility, and 3) molar volume.



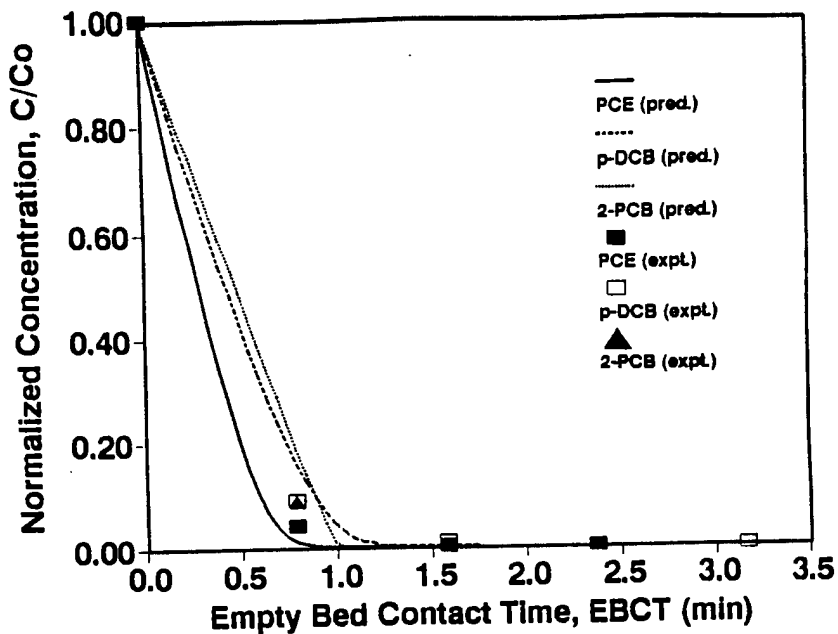

Figure 7. Comparison of experimental data and model prediction for destruction of PCE, *p*-DCB and 2-PCB.

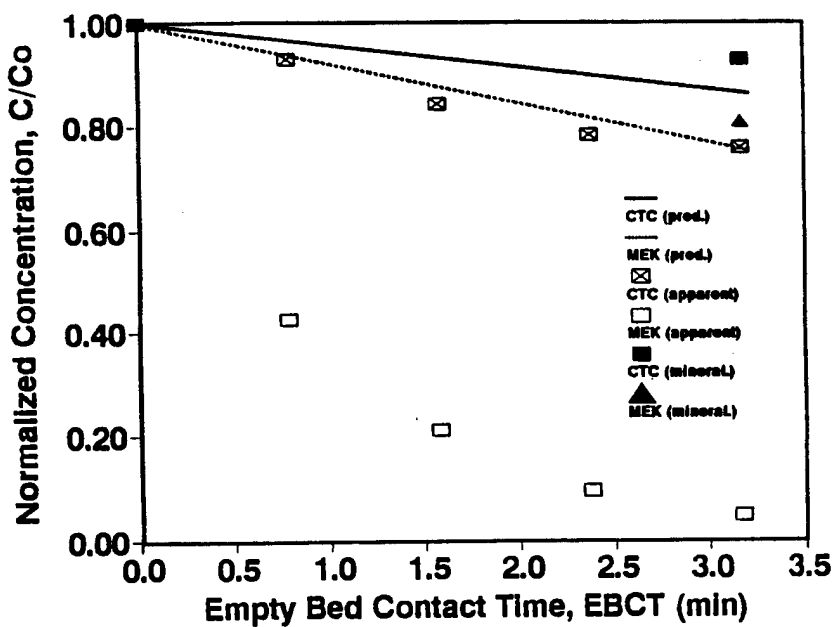

Figure 8. Comparison of experimental data and model prediction for destruction of CTC and MEK.

The rate constants determined using the tanning lamps were used to predict solar TCE destruction. The model prediction was compared with the solar experimental data and a satisfactory data description was obtained as shown in Figure 6. Figure 7 shows the experimental destruction data of PCE, *p*-DCB and 2-PCB and the model predicted curves. For these compounds, the mineralization was compatible to the apparent destruction. Figure 8 shows the experimental destruction data of MEK and CTC and the predicted results seemed much slower than the apparent destruction. However, as also shown in the figure, the predicted results were much closer to the mineralization data.

## ***2. Modeling Based on Slurry Photocatalysis***

Another model was developed to describe organic destruction using slurry form  $\text{TiO}_2$ . TCE destruction using  $\text{TiO}_2$  slurry was evaluated with the impact of the following factors: (1) organic solute concentration, (2) incident light intensity, (3) dissolved oxygen (DO) concentration, and (4) catalyst dosage. The model uses the Langmuir-Hinshelwood rate expression and describes TCE destruction data well.

## SECTION III

### PROCESSES USING ADSORPTION AND REGENERATION WITH AOPS

In the process, development using adsorption followed by regeneration, the operational principle consisted of two steps: (1) the organic compounds were removed and accumulated using fixed-bed adsorption, and (2) the adsorbents were regenerated and the organic compounds were destroyed using a) homogeneous AOPs, b) photocatalysis, or c) the combination of steam and photocatalysis.

#### A. **HOMOGENEOUS AOPS FOR ADSORBENT REGENERATION** (*As described by Literature Contribution 8; Mourand's M. S. Thesis*)

Two homogeneous AOPs, hydrogen peroxide/ozone and hydrogen peroxide/UV light, were used for adsorbent regeneration. The adsorbents first were loaded with organics using fixed-bed adsorption, were transferred to a reactor for regeneration, and, finally, were tested for the recovery of adsorption capacity, using fixed-bed adsorption again. The processes were evaluated by the regeneration rate, the consumption of oxidant and electrical energy, and the recovery of adsorption capacity.

Using hydrogen peroxide/ozone option, stoichiometry requires six moles of  $O_3$  and three moles of  $H_2O_2$  to destroy every mole of TCE. Using hydrogen peroxide/UV light, stoichiometry requires one and three moles of  $H_2O_2$  to destroy one mole of chloroform and one mole of TCE, respectively. Based on previous AOP studies treating water directly, oxidants of three to six times the stoichiometric requirement were used for spent adsorbent regeneration.

For both the options, the regeneration rate was much faster for smaller particle size adsorbents and weakly adsorbed compounds; in some cases, nearly 100% virgin capacity

was recovered after regeneration. However, the regeneration process consumed more oxidants for both options than were required if simply using a conventional AOP to destroy the organic contaminants directly. Neither option is feasible because the desorption rate is too slow and therefore too much oxidant is required to regenerate the adsorbents.

## **B. PHOTOCATALYSIS FOR DESTRUCTION AND REGENERATION** (*As described by Liu and Suri's Ph. D. Dissertations*).

F-400 granular activated carbon and Ambersorb<sup>®</sup> 563 resin were impregnated with platinumized Aldrich TiO<sub>2</sub> prior to being loaded with TCE or *p*-DCB. The adsorbent impregnation with photocatalyst was conducted in two steps. In the first step, titanium isopropoxide solution (with 20% by volume of 2-propanol) was hydrolyzed on the adsorbent in a humid environment then calcined at 500°C for three hours. This process, is expected to cause the catalyst to be impregnated onto the internal surface of the adsorbent. In the second step, catalyst was brought onto the external surface of the adsorbent by immersing the adsorbent in an aqueous slurry of Pt-Aldrich TiO<sub>2</sub> for 10 minutes. Then the catalyst/adsorbent was washed for several times and dried; the final catalyst dosage loaded on an impregnated adsorbent was determined by ash content analysis.

Rapid small-scale column tests (RSSCTs) were used to load the adsorbents. The spent adsorbents were regenerated in laboratory using various photoreactor options. The impact of light intensity and temperature on the regeneration rate were investigated to optimize the photocatalytic regeneration process. In addition, the effect of catalyst loading was evaluated on TCE adsorption capacity of TiO<sub>2</sub> impregnated F-400.

### ***1. Photocatalysis Alone for Adsorbent Regeneration***

Photocatalytic oxidation was used to regenerate spent adsorbents and destroy organic adsorbates simultaneously. Nearly all of the desorbed TCE and *p*-DCB were

dechlorinated during the regeneration. The working capacity for an influent TCE of 1 mg/L is about 70% and 60% the virgin capacity of F-400 and Ambersorb 563, respectively. No initial TCE breakthrough was found for both the adsorbents regenerated four times. For the strongly adsorbing compound, p-DCB, no stable working capacity was found with F-400. Less than 40% the p-DCB was mineralized during each regeneration/destruction cycle. After three regeneration cycles, the Ambersorb 563 achieved a stable working capacity for p-DCB (0.5 - 2.5 mg/L) which was approximately 20% of its virgin capacity. Nearly all the loaded adsorbates were mineralized with this adsorbent.

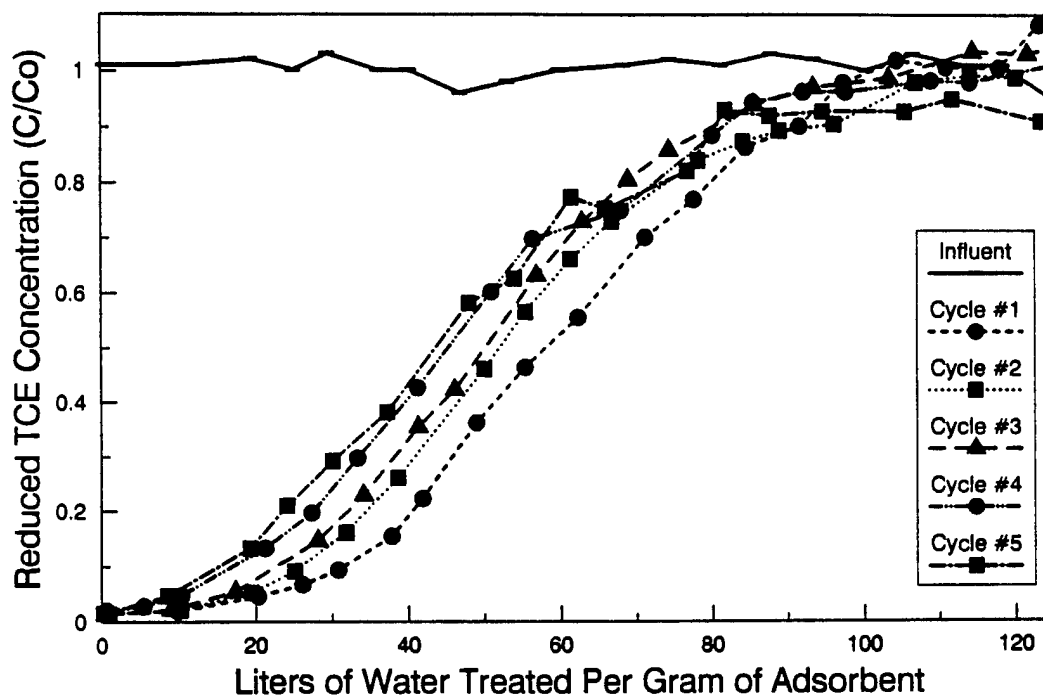

Figure 9. TCE concentration profiles of impregnated F-400. The initial concentration is 1.0 mg/L.

The amount of photocatalyst loaded onto the external adsorbent surface has no significant impact on the adsorption capacity of the adsorbent and the photocatalysis

retains its activity for up to four regeneration cycles. Figure 9 shows a TCE concentration profile of impregnated F400 for several cycles. No significant differences in regeneration efficiency were observed using various impregnation methods.

The regeneration process was mainly limited by the desorption of adsorbates from the interior to exterior surface of an adsorbent. Accordingly, temperature played a vital role in the photocatalytic regeneration process. Increasing temperature was much more effective to enhance the regeneration rate than increasing light intensity. To become a viable economic option, photocatalytic regeneration must have a quantum efficiency higher than that of the fixed-bed or slurry reactors to justify the expense of the adsorption step. The quantum efficiency of the regenerations was estimated to be on the order of  $10^4$ , in contrast to  $10^{-1}$  to  $10^{-2}$  for if treating the water directly with slurry or fixed-bed photoreactors. One way to maximize the photocatalytic regeneration efficiency is to increase the desorption rate through heating to match the photocatalytic oxidation rate; this is discussed in SECTION IV.

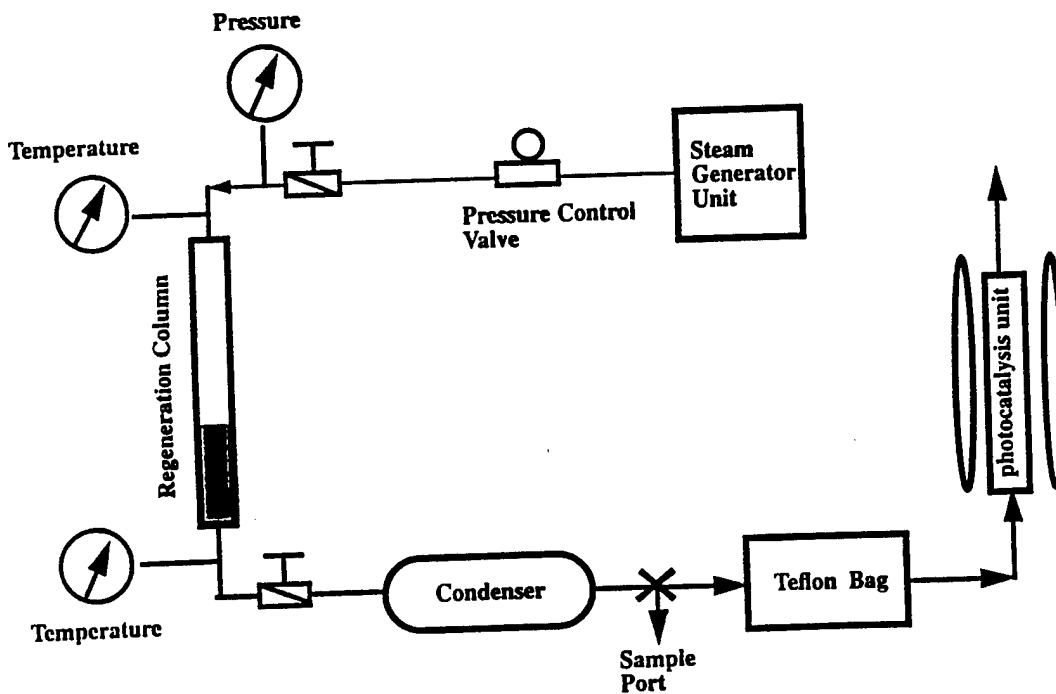

Figure 10. Schematic of the steam regeneration unit.

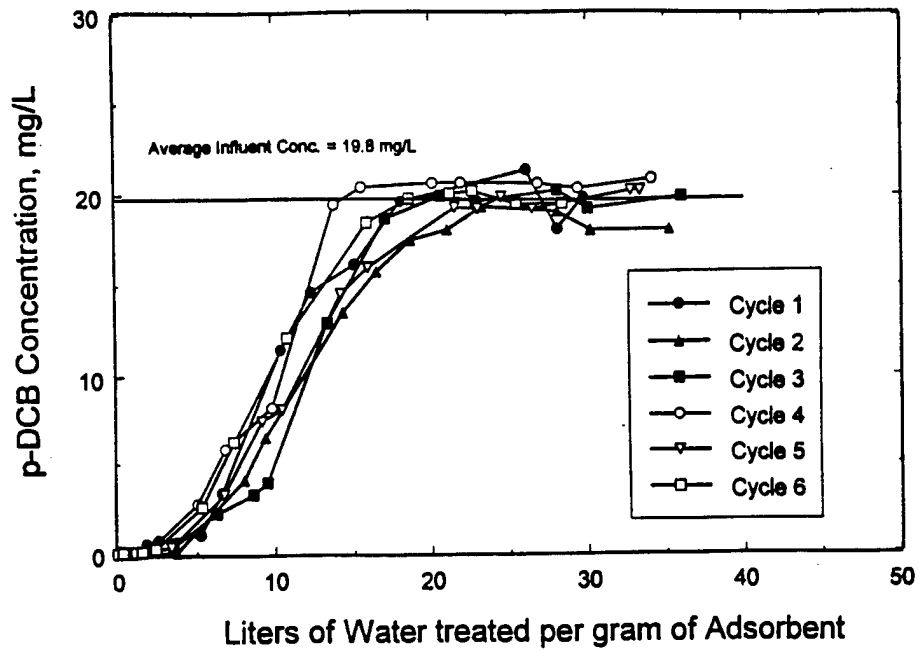

Figure 11. p-DCB adsorption profiles with Ambersorb® 563 adsorbent; Bed depth = 7 cm; EBCT = 25 sec; Velocity = 10 m/ hour.

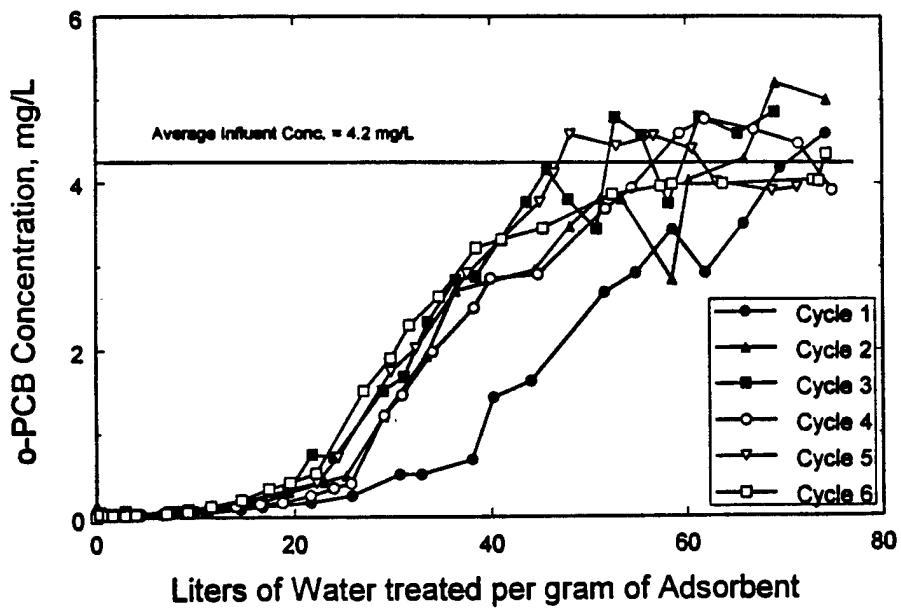

Figure 12. 2-PCB adsorption profiles with Ambersorb® 563 adsorbent; Bed depth = 6.2 cm; EBCT = 22 sec; Velocity = 10 m/ hour.

## **2. *Steam Followed by Photocatalysis for Regeneration***

In this treatment strategy, aqueous phase organic compounds were removed using fixed-bed adsorption, spent adsorbents were regenerated off-line using steam, and the regeneration fluid was treated using photocatalysis. Figure 10 shows a schematic of the steam-regeneration unit. The adsorbents loaded with PCE, CTC, p-DCB, 2-PCB, and MEK were regenerated, using saturated steam at 160°C. For six cycles of adsorption and regeneration, the adsorption capacity of the adsorbent for PCE, CTC, and MEK was completely recovered using the steam-regeneration process. For the two high boiling point compounds studied, p-DCB and 2-PCB, the steam regeneration was also successful. As shown in Figure 11, the adsorption capacity for p-DCB was completely recovered for six cycles of adsorption and regeneration studied. As shown in Figure 12, about a 20% loss in 2-PCB adsorption capacity was found after the first cycle, however, the adsorption capacities for Cycle 2 through Cycle 6 remained approximately the same. The photocatalytic oxidation process was observed to be effective for the destruction of desorbed organic compounds in the steam condensate.

### **C. MODELING ON STEAM ENHANCED DESORPTION**

A limited modeling effort was made in describing the desorption step in the steam regeneration process. The following were the objectives of the modeling efforts: (1) to determine the controlling mechanisms of the regeneration process; (2) to determine the impact of some process variables such as temperature and flow rate on the regeneration efficiency; and (3) to provide a tool for the design of a pilot plant unit. Mathematical models have been developed at MTU to describe the fate of an adsorbate within a fixed-bed adsorber [24,25]. The existing plug flow pore and surface diffusion model (PFPSDM), which was originally developed by Friedman [25], was modified and used to model the regeneration process.



Regeneration of spent adsorbents using saturated steam involves three mechanisms: (1) steam heating the adsorbent and providing the energy for desorption of the adsorbate; (2) steam, competing with the adsorbate for the adsorbent sites; and (3) steam flow carrying the desorbed adsorbate vapors to the outlet. Both equilibrium and mass transfer parameters are needed for the model development. The model parameter determination is discussed elsewhere. Mechanistically, the model assumes the pores are filled with water and this is an appropriate assumption for saturated steam.

The model describes the experimental data very well for PCE and CTC. Sensitivity analysis on steam temperature showed that organic desorption was enhanced with increased temperature. Sensitivity analysis also showed that low flow rate provided a higher concentration of the desorbed organic for a certain period. However, for complete regeneration of adsorbent, the required amount of steam seemed independent of the flow rate. A lower flow rate would require a longer regeneration time. If time is not an issue, using a lower flow rate may be beneficial in reducing the capital and operating costs of the steam-regeneration unit.

## SECTION IV

### FIELD TESTS AND DEMONSTRATION OF DEVELOPED TECHNOLOGIES

Three field tests were conducted using the technologies developed in this project. The first field test was conducted in the January and February in 1993 at Tyndall AFB, FL. This field test studied the remediation of fuel-contaminated groundwater with two options: (1) the solar photocatalytic fixed-bed process using Pt-TiO<sub>2</sub> supported on silica gel; (2) fixed-bed process using Pt-TiO<sub>2</sub> impregnated adsorbents alone or in combination with Pt-TiO<sub>2</sub> supported on silica gel. In the second field test, the fixed-bed photocatalytic process demonstrated the treatment feasibility of groundwater on a pilot scale at K. I. Sawyer AFB, MI. A solar reactor panel comprising 80 tubular reactors was used at a flow rate of approximately one gallon per minute. In the third field test, a combination of the traditional adsorption and the newly developed photocatalysis technologies was used to treat contaminated groundwater at a water treatment plant site in Wausau, WI. Fixed-bed adsorption was used to remove and accumulate the organic compounds, then the spent adsorbents were regenerated off line using steam followed by photocatalysis.

#### A. **SMALL SCALE FIELD TESTS AT TYNDALL AFB** (*As described by Literature Contributions 5, 7, 10; and Zhang's Ph. D. Dissertation and Klun's M. S. Report*)

This part of the study reports the results of a field test conducted by MTU and The Air Force Civil Engineering Laboratory (now Armstrong Laboratory, Environics Directorate) in the winter of 1993 (January and February) at Tyndall Air Force Base (TYAFB), Florida, USA. The field test used a solar photocatalytic process to detoxify the fuel-contaminated groundwater. Contaminants of concern were benzene, toluene,

ethylbenzene and xylenes (BTEX compounds). The following were the objectives of the MTU field test: (1) to examine photocatalyst fouling and destruction inhibition, (2) to develop effective strategies and methods for pretreatment, (3) to investigate the technical feasibility of a single process using adsorption combined with solar fixed-bed photocatalysis to remove and destroy organics in the contaminated groundwater, and (4) to collect experimental data for scale-up design.

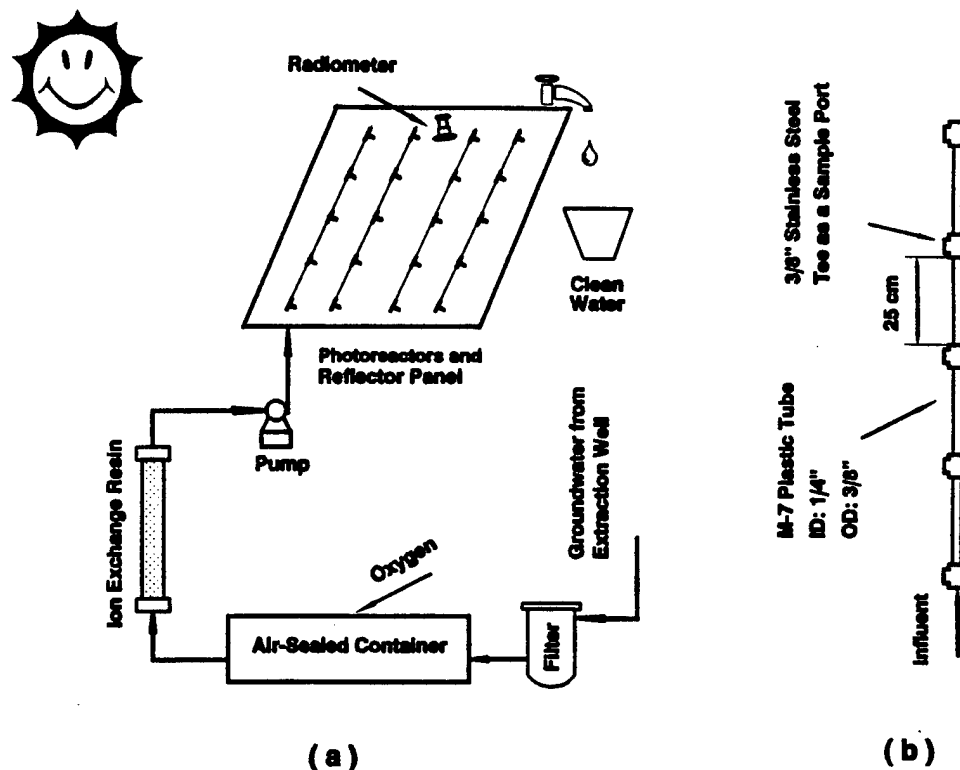

Figure 13. Schematic of the experimental setup used for the field test at Tyndall AFB, FL.

### 1. Test Using Photocatalyst Supported on Silica Gel

Pt-TiO<sub>2</sub>, supported on silica gel, was the most photoactive catalyst/support in previous studies, and was therefore used in this field test. The supported photocatalyst was packed in tubular photoreactors and used for single-pass operations. The photoreactors were constructed in series of varied length plastic tube segments made from

M-7 plastic (American Energy Technologies, Inc., Green Cove Springs, FL). Up to four reactors, as described in previous sections, were mounted in front of a flat-plate metal reflector. A schematic of the experimental setup is shown in Figure 13.

Catalyst fouling, destruction inhibition, and water pretreatment options were investigated in addition to BTEX destruction. Ionic species were found primarily responsible for photocatalyst fouling and destruction inhibition. Based on these results, a simple pretreatment unit was developed for removing turbidity, adding oxidant, and ionic species. The well water was pretreated to remove suspended particulates and dissolved species that could cause catalyst fouling and destruction inhibition. In addition, oxygen was added to increase DO and enhance the destruction rate. A mixed anionic and cationic ion exchange resin (0.55 meq/mL) was used to remove ionic species. To evaluate the impact of cationic species, several experiments were also conducted using a strong acid cationic resin (1.9 meq/mL). Cationic species were found more likely to inhibit the destruction process, rather than to foul the photocatalysts.

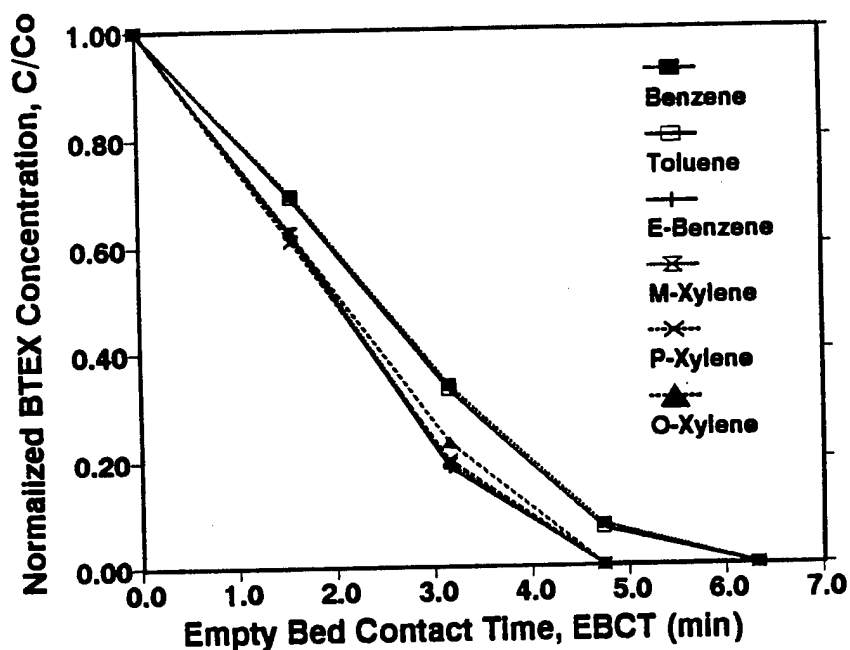

Figure 14. BTEX destruction in an experiment conducted on a rainy day.

The reactor system was operated efficiently by employing pretreatment. One reactor was kept in operation for 25 days to examine the pretreatment effectiveness and evaluate the long-term performance of the photocatalyst. The reactor was started at approximately 7:30 a.m. and stopped at 4:30 p.m. every day, regardless of weather conditions. No loss in catalyst photoactivity was found during the month-long test. As shown in Figure 14, BTEX compounds of a total influent concentration of more than 2 mg/L were destroyed within 6.5 minutes of EBCT on rainy days. Moreover, test results with various flow rates, reactor diameters, influent concentrations, solar irradiances and weather conditions confirm the application potential of the process.

The treatment cost was estimated to be \$5.52/1000 gallons, which was competitive with conventional technologies. However, this analysis is still preliminary and long-term tests are required to determine the actual pretreatment cost and catalyst life.

## **2. *Test Using Photocatalyst Supported on Adsorbents (As described by Klun's M. S. Report)***

Another continuous operation treatment strategy was field tested at Tyndall AFB, FL, using adsorption together with photocatalysis for groundwater contaminants removal and destruction.

Two different reactor design configurations were tested. The first design was a continuous flow configuration with three fixed-bed reactors in series. The first and third reactors were packed with platinized  $\text{TiO}_2$  supported on silica gel supports. The second reactor was packed with a photocatalyst-impregnated adsorbent. During daylight hours, the incoming organic compounds are destroyed in the first reactor. During the night or in periods of low light intensity, the organics were adsorbed onto photocatalyst-impregnated adsorbent in the second reactor. Subsequently, the adsorbed organics were either mineralized or partially mineralized in the second reactor, during daylight. The

remaining organics or destruction byproducts were destroyed in the third reactor. Because organic compounds can be adsorbed during periods of insufficient sunlight, the process can treat water continuously.

The above described process using a continuous-flow reactor was affected by catalyst fouling. After four days of operation, the process was apparently unable to further destroy any more BTEX compounds. Catalyst fouling was suspected, based on the fouling study and the use of pretreatment as described in SECTION IV. An ion exchange unit was added to the system and satisfactory BTEX destruction was resumed; however, the third reactor still did not perform well probably because fouling species desorbed from the second reactor.

Table 2. Calculated gas-phase detention times required for the photocatalytic destruction of selected VOCs in fixed-bed reactors.

<b>Compound (Initial Concentration)</b>	<b>Optimized Relative Humidity (% at 33°C)</b>	<b>Detention Time for 99% Destruction (seconds)</b>	<b>Detention Time for 99.9% Destruction (seconds)</b>
<b>TCE (5 ppm)</b>	<b>5-75 %</b>	<b>1.43 s</b>	<b>2.15 s</b>
<b>TCA (5 ppm)</b>	<b>~ 25 %</b>	<b>7.5 s</b>	<b>11.2 s</b>
<b>Toluene (115 ppm)</b>	<b>~ 55 %</b>	<b>~ 27 s</b>	<b>~40 s</b>

In the second design, a reactor packed with photocatalyst-impregnated adsorbents was used to remove the organics during darkness. During daylight, the

adsorbent was taken off line and regenerated by passing heated water through the reactor. The hot water then was passed through a fixed-bed reactor packed with platinumized  $\text{TiO}_2$  supported on silica gel supports to destroy any residual desorbed organics or byproducts. The strategy behind this design was to have an 18-hour adsorption period followed by a 6-hour regeneration period during which the solar irradiance is strong enough to destroy most contaminants.

The spent adsorbents were regenerated in the presence of sunlight while passing hot water ( $90^\circ\text{C}$ ) counter current to the flow direction during the adsorption process. The desorbed organics from the regeneration process were destroyed in the following fixed-bed photoreactor. The process was examined for 10 adsorption and regeneration cycles. Table 2 shows the mass balance on BTEX compounds for the 10 adsorption/regeneration cycles. The efficiency (ratio of organics removed and destroyed to organics adsorbed) of the process to regenerate the adsorbents was examined for each cycle. Overall 21% of the total influent BTEX was destroyed, and 98% of the BTEX was removed from the waste stream. While the process appears to be effective for 10 cycles more cycles are required to determine whether steady-state is achieved.

## **B. FIELD DEMONSTRATION AT K. I. SAWYER AFB**

A pilot-scale field demonstration was designed, based on the results from the lab experiments conducted at MTU and the 1993 field test performed at Tyndall Air Force Base, Florida.

The photocatalysts used for the demonstration were Pt- $\text{TiO}_2$  supported on silica gel and the UV source used was the solar insolation. The design included a water pretreatment unit which included a turbidity filter, a bubble less oxygen contactor, and ion-exchange columns. A schematic of the pilot plant is shown in Figure 15.

The reactor used for the demonstration was a modified solar thermal reactor panel with 80 M-7 tubes mounted in parallel (operated in a single-pass fashion). The capacity

for each reactor panel was designed as 0.25 GPM. A metal reflecting plate was located underneath the tubes for each panel to enhance light utilization. A skid was designed to accommodate the pretreatment system and the reactor panels.

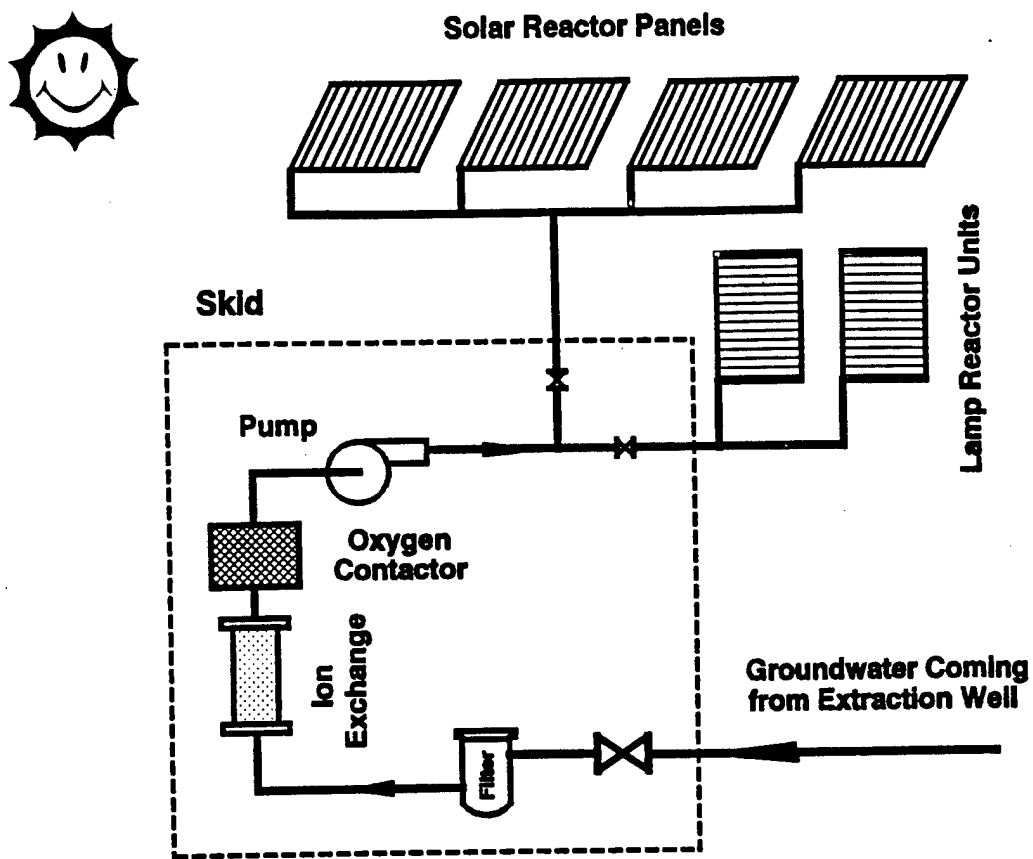

Figure 15. Schematic of the layout for a field demonstration.

After evaluating the reactor configuration in the laboratory at MTU, a field test was conducted at K. I. Sawyer AFB, MI. One solar reactor panel was tested at a flow rate up to one gallon per minute. The destruction of chlorinated contaminants (e.g., TCE, 100  $\mu\text{g/L}$ ) in the groundwater was monitored in the demonstration. In the afternoon of a sunny day in early August, using the panel destroyed more than 95% of the TCE within a 2-



minute contact time. The panel performance was compatible to results obtained from a tube reactor. The tube reactor served as a control during the demonstration under identical conditions.

**C. FIELD TEST AT WATER TREATMENT PLANT IN WAUSAU, WI** (*As described by Liu's Ph. D. Dissertation*)

Steam regeneration of spent adsorbents followed by photocatalysis to treat the steam condensate as a treatment option was evaluated in a pilot test study. A trailer containing the adsorption columns and pumps was set up at the water treatment plant in Wausau, Wisconsin. The groundwater was contaminated with PCE, TCE, *cis*-dichloroethene (*cis*-DCE) and toluene, ethylbenzene and xylenes.

F-400 GAC and Ambersorb<sup>®</sup> 563 adsorbents were used with Pt-TiO<sub>2</sub> impregnation and the as-received form. Direct photocatalytic oxidation was not effective for the regeneration of the spent adsorbent loaded with contaminated groundwater because the catalyst was fouled by background matter in the water matrix. Furthermore, as shown in the laboratory studies, the desorption of adsorbates limited the regeneration rate; consequently, the combination of steam regeneration followed by photocatalysis of steam condensate was evaluated. Four cycles of adsorption and three cycles of steam regeneration were performed. Ambersorb<sup>®</sup> 563 was successfully regenerated using saturated steam at 160°C within 20 hours. However, the F-400 carbon was not effectively regenerated and lost a significant amount of capacity. This was probably caused by background organic matter in the water matrix which cannot be removed from F-400 carbon using steam. The results of chloride yield with all the tested adsorbents showed no significant quantities of adsorbates were destroyed during the steam regeneration.

## SECTION IV

### CONCLUSIONS AND RECOMMENDATIONS

The major conclusions drawn from the results of this project are presented in this section. In addition, recommendations are given for future research.

#### A. CONCLUSIONS

One of the surface-modified commercially available photocatalysts, platinized Aldrich-TiO<sub>2</sub>, was the best for destroying hydrophobic compounds. This catalyst has a photoactivity as much as four times that of the best commercially available catalyst. A laboratory-developed photocatalyst, platinized MTU-TiO<sub>2</sub>, was found best for more hydrophilic compounds and for drinking water disinfection by-product (DBP) precursors.

Using Pt-TiO<sub>2</sub> supported on silica gel, the best supported photocatalyst developed, can completely mineralize chlorinated organic compounds in a short contact time. The destruction rate using Pt-TiO<sub>2</sub> supported on silica gel was four times that of the optimized slurry of Pt-TiO<sub>2</sub> and sixteen times that of the best commercially available catalyst slurry. This fixed-bed process can demonstrate a 40% light efficiency which is the ratio of organic molecules destroyed to UV photons required, much higher than the reported values which are commonly less than 5%.

The reactor model developed with organic spiked deionized water in this project can predict the mineralization of organic compounds using only their known physical and chemical properties and the applied UV irradiance. This model can predict solar destruction from artificial-light experiments. However, the model needs additional verification for a wider variety of compounds in order to be considered generally useful. This model be used in the processes in which water pretreatment is employed.

Research efforts also gave higher overall destruction rates when a support is modified to have larger adsorption capacity. When the adsorption capacity increased approximately a factor of five with the modified silica gel, the overall kinetics is enhanced by a factor of 50%.

Much faster destruction kinetics was observed in the air-phase than in the water phase. This offers the treatment possibility stripping volatile compounds from water-phase followed by air-phase photocatalysis. In the air-phase reactions, relative humidity and chlorine radical interactions were found to have a significant impact. Phosgene and carbon monoxide, the two possible toxic by-products in air-phase photocatalysis, were not found above regulated levels.

For using homogenous AOPs and photocatalysis, the regeneration processes appear limited by the desorption of adsorbates from an adsorbent surface. In the two options of the homogeneous AOPs, the regeneration processes consumed more oxidants than would be required simply using a conventional AOP to destroy the organic contaminants directly.

Direct photocatalytic regeneration of carbon-based adsorbents is not feasible, due to low desorption rate and low light penetration. Light efficiency of the process was estimated on the order of  $10^{-4}$  as compared with  $10^{-1}$  to  $10^{-2}$  if treating water directly with fixed-bed or slurry photoreactors, respectively. The light efficiency for regeneration must be higher than fixed-bed or slurry reactors in order to justify the expense of using adsorption.

The regeneration strategy using saturated, steam overcame desorption limitation successfully even for compounds with high boiling points. Steam followed by photocatalysis was very effective to regenerate the spent adsorbents and to destroy the desorbed organic compounds in the steam or steam condensate. Limited modeling efforts show the possibility describing desorption in the steam regeneration process.

In the field test conducted at Tyndall Air Force Base, ionic species were found primarily responsible for photocatalyst fouling. For 25 days in continuous operation, no loss in catalyst photoactivity was found using the developed pretreatment strategy. BTEX

compounds (total influent concentration of approximately 2 mg/L) were destroyed within 2.6 minutes contact time on rainy days. Moreover, test results with various flow rates, reactor diameters, influent concentrations, solar irradiances and weather conditions confirm the application potential of the process.

The destruction of chlorinated groundwater contaminants was demonstrated on a pilot scale at K. I. Sawyer AFB, MI. The panel performance was comparable with a tube reactor under identical conditions.

In the Wausau field test conducted in Wausau, a spent synthetic adsorbent was successfully regenerated, using saturated steam within 20 hours; however, a spent activated carbon was not effectively regenerated for capacity recovery. The condensate from steam regeneration was treated using photocatalysis with a contact time of approximately 35 minutes.

## **B. RECOMMENDATIONS**

Extended gas phase studies were warranted to explore the potential applications of the fixed-bed photocatalytic process developed in this project. One of the potential applications in gas phase is the treatment of air stripping tower off-gas. Comparing with treating water directly, the gas-phase process benefits from faster kinetics and less possibility of catalyst fouling and destruction inhibition. Other gas-phase applications may include treatment of soil vapor extraction (SVE) off-gas, industry process vents, and indoor or close system air.

More possible applications of the fixed-bed photocatalytic process in the aqueous phase include removal of heavy metals, preparation of high purity/organic free water for special demand, and detoxification of low strength waste streams.

Photocatalyst development may further enhance reaction rates, in turn, increase energy efficiency (measured by quantum yield). Sensitization enables a photocatalyst to utilize photons with lower energies (longer wavelengths). Considering the solar spectral

distribution, the efficiency increase is potentially significant for solar application. Surface modification using less-expensive metals, such as silver instead platinum, may further decrease catalyst cost if a high photoactivity can be retained. Efforts should also be directed to design novel materials and modify commercially available materials to obtain the photocatalyst supports with desired properties such as adsorption, UV transmission and resistance to oxidation.

The mechanism of photocatalyst fouling and destruction inhibition needs detailed systematic investigation. Recommended work includes well-controlled experiments in the laboratory and on site verification in the field.

The pretreatment methods used in this study, i.e., turbidity filtration, oxygen addition and ion exchanging, are ways to operate conveniently in the field for a small scale treatment set up. Replacement with less expensive existing technologies, such as oxygen aeration, flocculation and coagulation, may be justified for larger-scale water treatment facilities. However, the effectiveness and suitability of these technologies for pretreatment in water treatment still require further evaluation.

Innovative photoreactor designs are desired to further explore the potentials of the supported photocatalysts. The designs should include both the solar and artificial UV sources. In solar applications, the major cost may come from the capital cost. While for using UV lamps, the major cost may be the operation and maintenance. Therefore, feasibility studies need to be conducted to identify when using UV lamps is more economical.

Further study of destruction mechanism and reaction pathways will lead to better understanding of photocatalysis. Ultimately, this will, in turn, benefit the future development of reactor models to better predict a water detoxification process. The modification of the model developed in this study considers dispersion and light penetration to better meet the needs of reactor design and system scale-up.

A larger-scale field trial over a longer time is required to further validate the technical and economic feasibility of using fixed-bed photocatalysts for water treatment.

The steam regeneration should be optimized for process variables such as type of steam (saturated or super heated), steam temperature, flow rate, and regeneration time. To perform material balance, adsorbate desorption should be monitored during regeneration.

## REFERENCES

- [1] Aieta, E. M., Reagan, E. M., Lang J. S., McReynolds, L., Kang, J. W. and Glaze W. H. "Advanced Oxidation Processes for Treating Groundwater Contaminated with TCE and PCE: Pilot-Scale Evaluations." *Journal of the American Water Works Association*, 1988, **80**, 64.
- [2] Ollis, D. F., "Contaminant Degradation in Water," *Environ. Sci. Technol.* 1985, **19**, 480.
- [3] Ollis, D. F.; Pelizzetti, E., and Serpone N., "Photocatalyzed Destruction of Water Contaminants," *Environ. Sci. Technol.* 1991, **25**, 1523.
- [4] Dibble, L. A., and Raupp, G. B. "Kinetics of the Gas-Solid Heterogenous Photocatalytic Oxidation of Trichloroethylene by Near UV Illuminated Titanium Dioxide." *Catalysis Letters*, 1990, **4**, 345.
- [5] Dibble, L. A., and Raupp, G. B. "Fluidized-Bed Photocatalytic Oxidation of Trichloroethylene in Contaminated Airstreams." *Environmental Science and Technology*, 1992, **26**, 492.
- [6] Phillips, L. A., and Raupp, G. B. "Infrared Spectroscopic Investigation of Gas-Solid Heterogenous Photocatalytic Oxidation of Trichloroethylene." *Journal of Molecular Catalysis*, 1992, **77**, 297.
- [7] Nimlos, M. R., Jacoby, W. A., Blake, D. M., Milne, T. A. "Direct Mass Spectrometric Studies of the Destruction of Hazardous Wastes. 2. Gas-Phase Photocatalytic Oxidation of Trichloroethylene over TiO<sub>2</sub>: Products and Mechanisms." *Environmental Science and Technology*, 1993, **27**, 732.
- [8] Link, 1990. Economics of Solar Photocatalyzed Water Detoxification. A report prepared by Solar Energy Research Institute (SERI) for the National Research Council Committee on Potential Application of Concentrated Solar Photons. Golden, CO.

- [9] Hand, D. W. "Destruction of Disinfection By-Product Precursors Using Photoassisted Heterogenous Catalytic Oxidation." Ph. D. Dissertation, Michigan Technological University, Houghton, MI, 1991.
- [10] Suri, R. P. S. "Heterogenous Photocatalytic Destruction of Hazardous Organic Contaminants in Water." M. S. Thesis, Michigan Technological University, Houghton, MI, 1992.
- [11] Domen, K., et al. "Photocatalytic Decomposition of Water into H<sub>2</sub> and O<sub>2</sub> over NiO-SrTiO<sub>3</sub> Powder 1. Structure of the Catalyst." *Journal of Physical Chemistry*, 1986, **90**, 292.
- [12] Grätzel, M., "Colloidal Semiconductors," *Photocatalysis, Fundamentals and Applications* N. Serpone and E. Pelizzetti (Eds.), 1989, Wiley, New York, Chapter 6, 123.
- [13] Kraeutler, B., and Bard, A. "Heterogenous Photocatalytic Decomposition of Saturated Carboxylic Acids on TiO<sub>2</sub> Powder: Decarboxylative Route to Alkanes." *Journal of the American Chemical Society*, 1978, **100**, 5985.
- [14] Hand, D. W., Crittenden, J. C., Perram, D. L. "Destruction of Disinfection By-Product Precursors Using Photoassisted Heterogenous Catalytic Oxidation". Final report prepared for AWWA Research Foundation, Denver, CO, 1991.
- [15] Mark Mehos, NREL, personal communication.
- [16] Borgarello, E., Kiwi, J., Pelizzetti, E., Visca, M., Gratzel, M. "Sustained Water Cleavage by Visible Light." *Journal of the American Chemical Society*, 1981, **103**, 6324.
- [17] Borgarello, E., Kiwi, Gratzel, M., J., Pelizzetti, E., Visca, M. "Visible Light Induced Water Cleavage in Colloidal Solutions of Chromium-Doped Titanium Dioxide Particles." *Journal of the American Chemical Society*, 1982, **104**, 2996.



- [18] Pelizzetti, E., and Visca, M. "Bifunctional Redox Catalysis: Synthesis and Operation in Water-Cleavage Reactions. Energy Resources through Photochemistry and Catalysis," Gratzel, M., editor, New York, 1983.
- [19] Yan, M. F., and Rhodes, W. W. "Low Temperature Sintering of TiO<sub>2</sub>." *Materials Science and Engineering*, 1983, **61**, 59.
- [20] Zhang, Y., Crittenden, J. C., Hand, D. W., and Perram, D. L. "Fixed-bed Photocatalysts for Solar Decontamination of Water." *Environmental Science and Technology*, 1994, **28**, 435.
- [21] Zhang, Y., Crittenden, J. C., Hand, D. W., Perram, D. L., Marchand, E. G. "Solar Detoxification of Fuel-Contaminated Groundwater Using Fixed-Bed Photocatalyst." Submitted for publication in *Water Environment Research*, 1994.
- [22] Sontheimer, H., Crittenden, J. C. and Summers R. S., 1988, Activated Carbon for Water Treatment, DVGW-Forschungsstelle, Distributed in the USA by AWWA Research Foundation.
- [23] Kukolev, G. V., The Chemistry of Silicon and the Physical Chemistry of the Silicates, Yorkshire, Eng.: National Lending Library for Science and Technology, 1971.
- [24] Crittenden, J. C., Wong, B. W., Thacker, W. E., Snoeyink, V. L., and Hinrihs, R. L., "Mathematical Model of Sequential Loading in Fixed-Bed Adsorbers," *J. of WPCF*, 1980, **52**, 2780.
- [25] Friedman, G., "Mathematical Modeling of Multicomponent Adsorption in Batch and Fixed-Bed Reactors," M. S. Thesis, 1984, Michigan Technological University, Houghton, MI.

## LITERATURE CONTRIBUTIONS

1. Suri, R. P. S, Liu, J., Hand, D. W., Crittenden, J. C., Perram, D. L., and Mullins, M. E., "Heterogenous Photocatalytic Oxidation of Hazardous Organic Contaminants in Water," *Water Environment Research*, 1993, **65**, 565.
2. Zhang, Yin; Crittenden, J. C.; Hand, D. W.; Perram, D. L., "Method and Apparatus for Destroying Organic Compounds in Fluid," *US Patent: 5,501,801*, March 26, 1996.
3. Zhang, Yin, Crittenden, J. C., Hand, D. W., and Perram, D. L., "Fixed-bed Photocatalysts for Solar Decontamination of Water," *Environmental Science and Technology*, 1994, **28**, 435.
4. Zhang, Yin, Crittenden, J. C., Hand, D. W., "The Solar Photocatalytic Decontamination of Water" *Industry & Chemistry*, 1994, **18**, 714.
5. Zhang, Yin, Crittenden, J. C., Hand, D. W., Perram, D. L., Marchand, E. G., "Solar Detoxification of Groundwater Using Fixed-Bed Photocatalysts" *Water Environment Federation 67th Annual Conference*, 1994, **2**, 659.
6. Crittenden, J. C., Zhang, Yin, Hand, D. W., Perram, D. L., "Destruction of organic compounds in water using fixed-bed photocatalysts," *Solar Engineering, ASME, The 1995 International Solar Energy Conference*, 1995, **1**, 449.
7. Crittenden, J. C., Zhang, Yin, Hand, D. W., Marchand, E. G., "Sun fuels Groundwater Remediation" *Water Environment & Technology*, 1995, **7**, No. 2, 15.
8. Mourand, J. T., Crittenden, J. C., Hand, D. W., Perram, D. L., Notthakun, S. "Regeneration of Spent Adsorbents Using Advanced Oxidation," *Water Environment Research*, 1995, **67**, 355.
9. Zhang, Yin, Crittenden, J. C., Hand, D. W., Perram, D. L. "Destruction of Organic Compounds in Water Using Supported Photocatalysts," Accepted for publication

in *Journal of Solar Energy Engineering*, 1994.

10. Crittenden, J. C., Zhang, Yin, Hand, D. W., Perram, D. L., Marchand, E. G. "Solar Detoxification of Fuel-Contaminated Groundwater Using Fixed-Bed Photocatalyst," Accepted for publication in *Water Environment Research*, 1994.

## MANUSCRIPTS SUBMITTED FOR PUBLICATION

1. Liu, J. B., Crittenden, J. C., Hand, D. W., Perram, D. L., "Regeneration of Adsorbents Using Heterogeneous Photocatalytic Oxidation," Accepted for publication in *Journal of Environmental Engineering*, 1996. Partially Supported.
2. Egorova-Cheesemen, O., Crittenden, J. C., Hand, D. W., and Mullins, M. E., "Surface Modified Silica Materials as Adsorbent Supports for Titanium Dioxide Moderated Aqueous Heterogeneous Photocatalytic Oxidation," Submitted for publication in *Environmental Science and Technology*, 1996, partly supported.
3. Crittenden, J. C., Suri, R. P. S., Perram, D. L., Hand, D. W., "Decontamination of Water using Adsorption and Photocatalysis" Submitted for publication in *Journal of Environmental Engineering*, 1995.
4. Suri, R. P. S., Crittenden, J. C., Hand, D. W., Perram, D. L., "Steam Regeneration of Adsorbents, and Photocatalytic Destruction of Organic Compounds," Submitted for publication in *Water Environment Research*, 1995.
5. Liu, J. B., Crittenden, J. C., Hand, D. W., Perram, D. L., "Destruction of Chlorinated Hydrocarbon in Water Using Heterogeneous Photocatalytic Oxidation", Accepted for publication in *Water Research*, 1996, partly supported.
6. Liu, J. B., Crittenden, J. C., Hand, D. W., Perram, D. L., "Removal and Destruction of Organic Contaminants in Water Using Adsorption, Steam Regeneration, and Photocatalytic Oxidation -Pilot Study," Submitted for publication in *Journal of AWWA*, 1995, partly supported.
7. Hand, D. W., Rollman, R. T., Crittenden, J. C., Perram, D. L., Zhang Yin, "Destruction of Volatile Organic Compounds Using Air-Phase Photocatalysis," Submitted for publication in *Journal of Air & Waste Management*, 1995, partly supported.

## POSTER AND PRESENTATION CONTRIBUTIONS

1. Suri, R. P. S., Hand, D. W., Crittenden, J. C., Perram, D., Notthakun, S., Mullins, M. E. "Photoassisted Catalytic Oxidation of Organic Contaminants in Water," presented at the annual Water Environment Federation (WEF) conference in Toronto, 1991.
2. Suri, R. P. S., Hand, D. W., Crittenden, J. C., Perram, D., Liu, J., Mullins, M. E. "Heterogenous Photocatalysis over  $\text{TiO}_2$  and Pt- $\text{TiO}_2$  Catalysts," a poster presented at the annual American Water Works Association (AWWA) conference in Vancouver, 1992.
3. Hand, D. W., Liu, J., Suri, R. P. S., Crittenden, J. C., Perram, D. "Photocatalytic Advanced Oxidation Processes," presented at the Advanced Oxidation Processes Workshop, sponsored by the International Water Supply Association and the American Water Works Association, in Miami, Florida, 1992, partly supported.
4. Suri, R. P. S., Liu, J., Zhang, Yin, Hand, D. W., Crittenden, J. C., Perram, D., Mullins, M. E. "Destruction of Organic Compounds in Water Employing Heterogenous Photocatalysis," a poster presented at the Gordon Research Conference, New Hampton, New Hampshire, 1992, partly supported.
5. Crittenden, J. C., et al. "Photocatalytic Decontamination of Water," presented at the Gordon Research Conference, New Hampton, New Hampshire, 1992.
6. Zhang, Yin, Crittenden, J. C., Hand, D. W., Perram, D. L., Marchand, E. G., "Detoxification of Fuel-Contaminated Groundwater Using Continuous Flow Reactor Packed with Supported Photocatalysts," presented at the 1994 Annual AIChE Meeting, San Francisco, CA, November 1994.
7. Zhang, Yin, Crittenden, J. C., Hand, D. W., Perram, D. L., Marchand, E. G., "Solar Detoxification of Groundwater Using Fixed-Bed Photocatalysts," presented at the Water Environment Federation 67th Annual Conference, Chicago, IL, October 1994.

8. Zhang, Yin, Crittenden, J. C., Hand, D. W., Perram, D. L., "Solar Decontamination of Water with  $\text{TiO}_2$  Photocatalyst on Silica Based Supports," presented at the American Water Works Association Annual Conference, San Antonio, TX, June 1993.
9. Crittenden, J. C., Zhang, Yin, Hand, D. W., Perram, D. L., "Destruction of Organic Compounds in Water Using Fixed-bed Photocatalysts," presented at *The 1995 International Solar Energy Conference*, Maui, Hawaii, March 19-24, 1995.
10. Suri, R. P. S., Zhang, Yin, Liu, B., Crittenden, J. C., Hand, D. W., Perram, D. L., "Heterogeneous Photocatalytic Oxidation of Hazardous Organic Contaminants in Water," presented at *Water Environment Federation 66th Annual Conference*, Anaheim, CA, October 1993.
11. Suri, R. P. S., Zhang, Yin, Crittenden, J. C., Hand, D. W., Perram, D. L., "Innovative and Clean Industrial treatment Technologies," Presented at the *1993 Michigan Water Environment Federation Annual Conference*, Boyne Highlands, MI, June 1993.
12. Hand, D. W.; Crittenden, J. C.; Zhang, Yin; and Erich G. Klun, (1992) "Photocatalytic Decontamination of water Using Sunlight and  $\text{TiO}_2$  Impregnated Adsorbent and Non-adsorbent Supports," presented at: *The First International Conference on  $\text{TiO}_2$  Photocatalytic Purification and Treatment of water and air*, London, Canada, November, 1992.
13. Crittenden, J. C., Zhang, Yin, Hand, Suri, P. S., Liu, B., D. W., Perram, D. L., Klun, E. G., Notthakun, S., and Mullins, M. E., "Photocatalytic Decontamination of Water" *Hazardous Waste Conference*, Notre Dame, IN, August 1992.
14. Crittenden, J. C., Zhang, Yin, Hand, Suri, P. S., Liu, B., D. W., Perram, D. L., Klun, E. G., Notthakun, S., and Mullins, M. E., "Photocatalytic Decontamination of Water," *Michigan Environmental Technology Innovation Conference*, E. Lansing, MI, September 1992.

15. Crittenden, J. C., Zhang, Yin, Hand, Suri, P. S., Liu, B., D. W., Perram, D. L., Klun, E. G., Notthakun, S., and Mullins, M. E., "Photocatalytic Decontamination of Water," *Florida Environmental Chemistry Conference*, Palm Coast, FL, October 1992.
16. Crittenden, J. C., Zhang, Yin, Hand, Suri, P. S., Liu, B., D. W., Perram, D. L., Klun, E. G., Notthakun, S., and Mullins, M. E., "Photocatalytic Decontamination of Water," *USEPA Risk Reduction Engineering Laboratory Workshop on Process Simulation and Optimization with Environmental Considerations*, Cincinnati, OH, December 1992.
17. Crittenden, J. C., Zhang, Yin, Hand, Suri, P. S., Liu, B., D. W., Perram, D. L., Klun, E. G., Notthakun, S., and Mullins, M. E., "Photocatalytic Decontamination of Water," *Seminar*, Johnson Space Center, Houston, TX, October 1992.
18. Suri, R. P. S., Liu, B., Hand, D. W., Crittenden, J. C., Perram, D. L., Zhang, Yin, Hokanson, D. R., and Mullins, M. E., "Destruction of Organic Compounds in Water Employing Heterogeneous Photocatalysis," presented at the *Poster Session, Gordon Research Conference, Environmental Sciences, Redox Processes in Environmental Sciences*, New Hampton, NH, June 1992.
19. Suri, R. P. S., Liu, B., Hand, D. W., Crittenden, J. C., Perram, D. L., Zhang, Yin, Hokanson, D. R., and Mullins, M. E., "Destruction of Organic Compounds in Water Employing Heterogeneous Photocatalysis," presented at the *Poster Session, American Water Works Association Annual Conference*, Vancouver B.C., Canada, June, 1992.

## DISSERTATIONS AND THESES

1. Zhang, Yin, "Detoxification of Water Using Supported Photocatalysts," Ph. D. Dissertation, Michigan Technological University, Houghton, MI, 1994.
2. Suri, R. P. S. "Thermal Regeneration of Adsorbents, and Photocatalytic Destruction of Hazardous Organic Compounds," Ph. D. Dissertation, Michigan Technological University, Houghton, MI, 1995.
3. Liu, J. B., Ph. D. Dissertation, "Removal and Destruction of Toxic Organic Contaminations in Water Using Adsorption and Photocatalytic Oxidation," Michigan Technological University, Houghton, MI, 1995, partially supported.
4. Suri, R. P. S. "Heterogenous Photocatalytic Oxidation of Hazardous Organic Contaminants in Water". M. S. Thesis, Michigan Technological University, Houghton, MI, 1992.
5. Mourand, J. T. "Regeneration of Spent Adsorbents Using Advanced Oxidation." M. S. Thesis, Michigan Technological University, Houghton, MI, 1993.
6. Egorova-Cheeseman, O. "Silica Gel Materials as Catalyst Supports for Photocatalytic Destruction of Organic Pollutants." M. S. Thesis, Michigan Technological University, Houghton, MI, 1993, partially supported.
7. Klun, E. "Removal and Destruction of BTEX Compounds from Contaminated Groundwater Employing Adsorption and Fixed-Bed Photocatalytic Oxidation." M. S. Thesis, Michigan Technological University, Houghton, MI, 1993.
8. Rollman, R. T. "Removal of VOC's using Supported Photocatalysts," M. S. Thesis, Michigan Technological University, Houghton, MI, 1994, partially supported.
9. Liu, Bin, "A Feasibility Study of Heterogeneous Photocatalytic Detoxification in Water," M. S. Report, Michigan Technological University, Houghton, MI, 1995, partially supported.